



Mobile Device Power Monitor Manual

Ver 1.20

Distributed By:

Monsoon Solutions, Inc.
2405 140th Avenue NE
Suite A115
Bellevue, Washington 98005
(425) 378-8081

Table of Contents

SYMBOLS USED IN THIS DOCUMENT	5
INTRODUCTION	6
HARDWARE AND SOFTWARE REQUIREMENTS FOR THE DEVELOPMENT WORKSTATION.....	8
INSTALLING THE POWERTOOL SOFTWARE, DRIVERS AND CONNECTING TO THE POWER MONITOR	
HARDWARE.....	9
Power Monitor Driver Installation	9
Firmware Driver Installation Instructions.....	10
Updating the Firmware	10
Connecting to the Power Monitor Hardware	11
Connecting the Power Monitor to a Device.....	14
USING THE POWERTOOL SOFTWARE	15
Checking the Software Revision of the Power Monitor	16
Powering-up and Powering-down a Mobile Device.....	17
Low Battery Warning on Device	18
Over-Current Error from the Main Power Supply	18
Protecting the Main Power Supply from an Over-Current Error.....	19
The Set Parameters Dialog Box.....	20
The Legend Dialog Box.....	21
The Scale Dialog Box	21
Sampling Data	22
Power Monitor Reset	23
Cursors.....	23
Statistics.....	24
Zoom.....	25
Triggers	26
USB Measurements.....	27
Measuring Power	28
Battery powered device, either with a battery blank or bypassed battery (mobile phone, etc.)	
.....	28
USB powered device (mouse, keyboard, etc.)	28
Measuring charging current.....	29
Battery powered device with active battery and connected to wall charger	29
Battery powered device with active battery and connected to computer.....	29
Auxiliary Port (Aux)	30
Calibrating the Aux Channel	30
Isolating current draw measurements at a specific point in a circuit in the device under test...33	
Measuring battery drain while device under test is exercised	34
Data Importing Features of the Power Monitor	35
Data Exporting Features of the Power Monitor	35
PT5 export details	36
CSV export details	36
FUNCTIONAL DESCRIPTION OF THE POWER MONITOR.....	37
APPENDIX:	39
FREQUENTLY ASKED QUESTIONS	39
Do you provide Linux or Mac support?	39
Do you provide higher or lower voltage support?.....	39
How do I test whether my unit is still in calibration?	40
Configuration Window Special Fields	41
RATINGS.....	42
Absolute Maximum ratings:.....	42
Environmental Conditions:	42

ELECTRICAL SPECIFICATIONS OF THE MOBILE DEVICE POWER MONITOR.....	43
Main Channel	43
USB Channel.....	44
Auxiliary Channel	45
CONNECTING AN EXTERNAL SUPPLY IN SERIES WITH THE POWER MONITOR(EXPERIMENTAL)	49
BATTERY BY-PASS MODIFICATION INSTRUCTIONS	50
Testing the Copper Tape Connections	51
POWER MONITOR DATA AND CONTROL PROTOCOL	51
COMMAND LINE OPERATION OF THE POWER MONITOR	51
Trigger codes	52
Capture Data Mask	56
POWER MONITOR EXIT CODES.....	56
PT5 FILE FORMAT.....	56
Header section	57
Interpreting the Sample Data	64
Missing data values.....	65
Example C# program to process a PT5 file	65
EQUIPMENT MAINTENANCE AND SERVICE.....	65
Inspection of the Power monitor for safety	65
How to Clean the Power Monitor	65

Document Revision History

Date Released	Revision Number	Notes
May 2007	1.0	Initial release
November 1, 2007	1.1	Updated features and added PT4 formats
January 16, 2008	1.2	Updated path for Power Monitor Install directory
July 15, 2008	1.3	Updated and added features
November 9, 2009	1.4	Corrected web site links
June 11, 2012	1.5	Consolidated manual
June 18, 2012	1.6	Updated Command Line usage directions and PT4 file reader example
June 21, 2012	1.7	Documented support for CSV and DCF export from Command Line version and triggers.
June 28, 2012	1.8	Updated pt4 reader example. It is now distributed as source code rather than inline in the document.
July 26, 2012	1.9	Updated application screenshots. Updated system memory requirements.
Aug 9, 2012	1.10	Updated information on recommendations for extended-duration testing and change in default time axis.
Aug 13, 2012	1.11	Updated to reflect USB channel changes.
November 28, 2012	1.12	Updated to reflect ability to disable automatic port scanning.
April 4, 2013	1.13	Updated to reflect .Net dependencies
May 29, 2014	1.14	Updated to clarify capture data masks and export capabilities. Various clarifications throughout the document, including significant documentation updates for USB and AUX channels. Added FAQs.
September 14, 2015	1.15	Updated to support Software V4.0.5.1
July 16, 2016	1.16	Updated for high voltage hardware and V5.0.0.0 of the software
April 14, 2016	1.17	Added absolute maximum ratings for inputs, environmental ratings, quick-disconnect instructions, and cleaning instructions
May 2, 2018	1.18	Added details for updated PowerToolCMD arguments, clarified OS recommendation for HVPM
June 6, 2018	1.19	Added clarification for driver use on LVPM with v32 firmware. Updated firmware table. Various content corrections and updates.

		Hardware rev G note added to HVPM specifications table.
March 25, 2019	1.20	Revised battery modification instructions

Symbols used in this document

The following symbols appear on the case of the Power Monitor, and are used throughout this document.





Symbol	Description
	Symbol indicates positive terminal of the main channel
	Symbol indicates negative terminal of the main channel
	Power Switch
	Caution. Symbol appears above Output Enable light.
	USB Port

Table 1 Symbols used in this document

Introduction

The PowerTool software and the Power Monitor hardware provide a robust power measurement solution for mobile devices. The PowerTool software and the Power Monitor hardware can analyze the power consumption of devices. Electrical engineers and software developers can utilize the PowerTool software and the Power Monitor hardware to optimize the design and analyze the performance of their mobile devices.

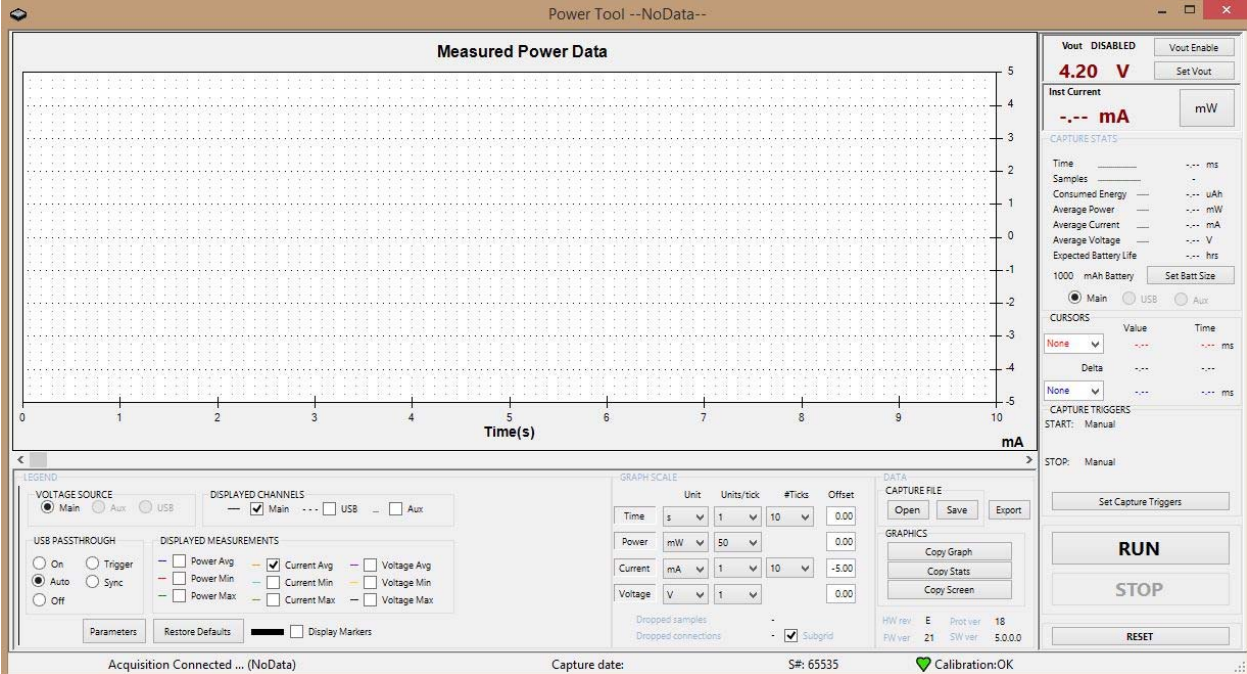

Figure 1 Graphical user interface (GUI) for the PowerTool software

The PowerTool software supports two different pieces of hardware. The current version is referred to as the High Voltage Power Monitor, or HVPM, for its expanded voltage and current range of 0.8-13.5V, and up to 6 Amps. The Legacy hardware is referred to as the Low Voltage Power Monitor, or LVPM, only supports a range of 2.01-4.55V, and up to 4.5A. Note that the voltage ranges and other hardware specifications throughout this manual refer to the HVPM. Legacy LVPM users should refer to the LVPM manual, which is available at <http://msoon.github.io/powermonitor/>

The Power Monitor can measure data on three channels: Main, USB, and Auxiliary. The Main channel is what most users will use for their measurements. A [USB channel](#) is provided as an [AUX channel](#). The GUI details are described below for the Main channel, but largely apply to all sampling sources. Cases where they differ are called out in the appropriate sections on USB or AUX measurements.



Figure 2 Mobile Device Power Monitor

Hardware and Software Requirements for the Development Workstation

A dedicated Windows platform workstation is required to be used with the Power Monitor to achieve the optimal performance and results. **Slower/older computers may not be able to process samples efficiently enough and users may see a significant number of dropped samples.**

- Windows Vista, Windows 7, Windows 8, or Windows 10 [XP support discontinued after 4.0.4.11] **HVPM only supported on Windows 8 or later**
- 1024x768 or greater screen resolution
- 3.2 GHz 32-bit (x86) processor.
- 4 GB of system memory
- 40 GB hard drive with at least 15 GB of available space
- Version 4.0.4.12 and 5.0.0.0 require .Net 4.5. Version 4.0.4.11 requires .Net 4.0. Versions 4.0.4.0-4.0.4.10 require .Net 3.5.
- Full Speed USB 2.0 – integrated chipset or PCI/PCI Express add in card.
- USB 3.0 or Downstream Charging ports are recommended for Front-panel connections. **USB Hubs, including monitor hubs, should not be used with the Power Monitor for optimal performance.**

Installing the PowerTool Software, Drivers and Connecting to the Power Monitor Hardware

Prior to installing the latest version, uninstall any previous version of the Power Monitor Software from the Control Panel.

Create a new temporary folder on the development workstation under the root directory (C:\).

Copy PowerTool.zip to the development workstation.

Extract the contents of PowerTool 5.X.X.X.zip to the temporary folder.

Run PowerTool Install.exe

Follow the on screen prompts to install the PowerTool Software.

Power Monitor Driver Installation

After the PowerTool application has been installed and this is the first time the workstation will be running the PowerTool application you will need to install two drivers, the Power Monitor driver and the Firmware driver. Instructions are as follows:

1. Power on Power Monitor in normal mode – Green led should be on.
2. Under Device Manager, find Mobile Device Power Monitor – will have a yellow exclamation mark.
3. Right click and select Update Driver Software...
4. Select Browse my computer for driver software
5. Browse to C:\Program Files (x86)\Monsoon Solutions Inc\PowerMonitor\Drivers\ and select the folder corresponding to your Power Monitor model and click Next.
Note: If you are using a LVPM with v32 firmware you will need to install the HVPM drivers, otherwise use the LVPM drivers.
6. Click on Close once the driver has finished installing.
7. Under Device Manager – Universal Serial Bus devices, ensure that the Mobile Device Power Monitor has enumerated properly.

Firmware Driver Installation Instructions

1. Power on the Power Monitor in Output Enable mode by depressing the Reflash (Output Enable on LVPM) button and the Power button simultaneously – Amber led should be on.
2. Under Device Manager find the Unknown device and right click, select Update Driver Software...
3. Select Browse my computer for driver software
4. Browse to C:\Program Files (x86)\Monsoon Solutions Inc\Power Monitor\Drivers\LVPM\Firmware and click on Next
5. Click on Close once the drive has finished installing.
6. Under Device Manager – Custom USB Devices verify that the Microchip Custom USB Device has enumerated properly.

Updating the Firmware

The Power Monitor is shipped with the latest firmware and in most cases will not be required to be updated. If for any reason the firmware does need to be updated use the following instructions.

Power on the Power Monitor in Output/Enable mode by pressing on the Output Enable button and Power button simultaneously. The amber light should be on.



Figure 3 Output Enable button

Start the PowerTool application, and select the Reflash option, which is enabled whenever a Power Monitor device in boot mode is detected.

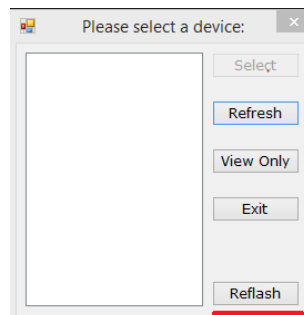

Figure 4 PM Flash Select Option

Click on the Load button and browse to the PMFlash folder where the PowerTool application was installed and select the PM_RevX_ProtXX_VerXX_Boot.fwm file. (Note, X is a placeholder for the proper version information for a given fwm file, for example, PM_RevD_Prot18_Ver21.fwm). The Reflash utility is also compatible with the deprecated .hex file format used in previous firmware releases.

Click on the Write button

Wait until the Status shows "Write complete".

Click on the X in the upper right of the window to exit when you are done.

Power off and then power back on the Power Monitor so you now have a green light.

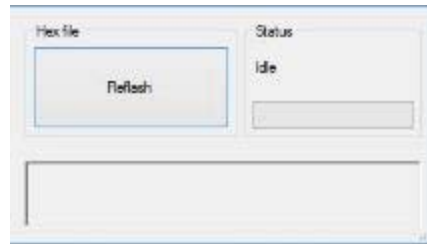

Figure 5 PM Flash Window

Connecting to the Power Monitor Hardware

1. Ensure to read all instructions carefully before operation. Using the Power Monitor in a manner not specified by this manual may damage the equipment and impair protections designed for user safety.
2. Be sure that the power switch on the front of the Power Monitor hardware is not engaged. The hardware should not be powered-up.
3. The power switch should be in the outward position, not the inward position.
4. Connect the supplied 16 VDC / 7.5 Amp, power supply to the back of the Power Monitor and a wall power supply matching the unit's input requirements (100-240V, 47-63 Hz, 1.6A Maximum)
5. The power supply should be positioned so that it is within easy reach in the event that it needs to be disconnected for safety. Ensure this by placing the power brick on the same work surface as the Power Monitor with the AC input side facing the user. Ensure there are no obstructions in the work area that may impede you in the event of an emergency.
6. On a development workstation that is compliant with Full-Speed USB 2.0, connect a USB cable to the USB connector on the back of the Power Monitor hardware, and connect the other end of the USB cable to the development workstation. Do not connect to an external USB hub device.

Do not connect a third party power supply to the Power Monitor. The connector used does not have a standard pinout, and an improperly selected Power Supply may damage the device. If a replacement power supply is required, contact Monsoon Solutions.



Figure 6 Back view: Power connector and USB connector

7. Turn on the Power Monitor hardware by engaging the power button on the front. The internal fan will briefly power-up and then power-down.
8. Initially, the power light-emitting diode (LED) is amber, and then it turns green. The green LED is connected directly to the internal power of the Power Monitor.



Figure 7 Front view: Engaged power button and powered-up green LED

Connecting the Power Monitor to a Device

Refer to the [Appendix](#) on how to properly configure a device battery to connect to the Power Monitor.

Note Wear ANSI Z87.1 compliant safety goggles at all times while working with exposed battery terminals and wiring.

Connecting the Power Monitor to a device to collect current measurements can be complicated and dangerous. Be sure that the area where power measurements are being conducted is protected from fire danger, do not have flammable items nearby. These measurements are at your own risk, and these procedures are not guaranteed to prevent damage or injury.

Note When attaching the power measurement hardware to a device with a lithium battery, there is always a risk of damaging the device, or causing the device to heat-up, generate smoke, or catch fire. While this is unlikely, be extremely careful. It is recommended to work on a flame-resistant surface and have fire control equipment at the ready when performing the battery bypass and connecting the Power Monitor to the device under test. Immediately disconnect equipment that begins to exceed safe temperatures.



Figure 8 A mobile device connected to the main channel

Using the PowerTool Software

After connecting the device, power up the Power Monitor and run the PowerTool software (PowerTool.exe). The software should connect to the Power Monitor, and display the user interface (UI).

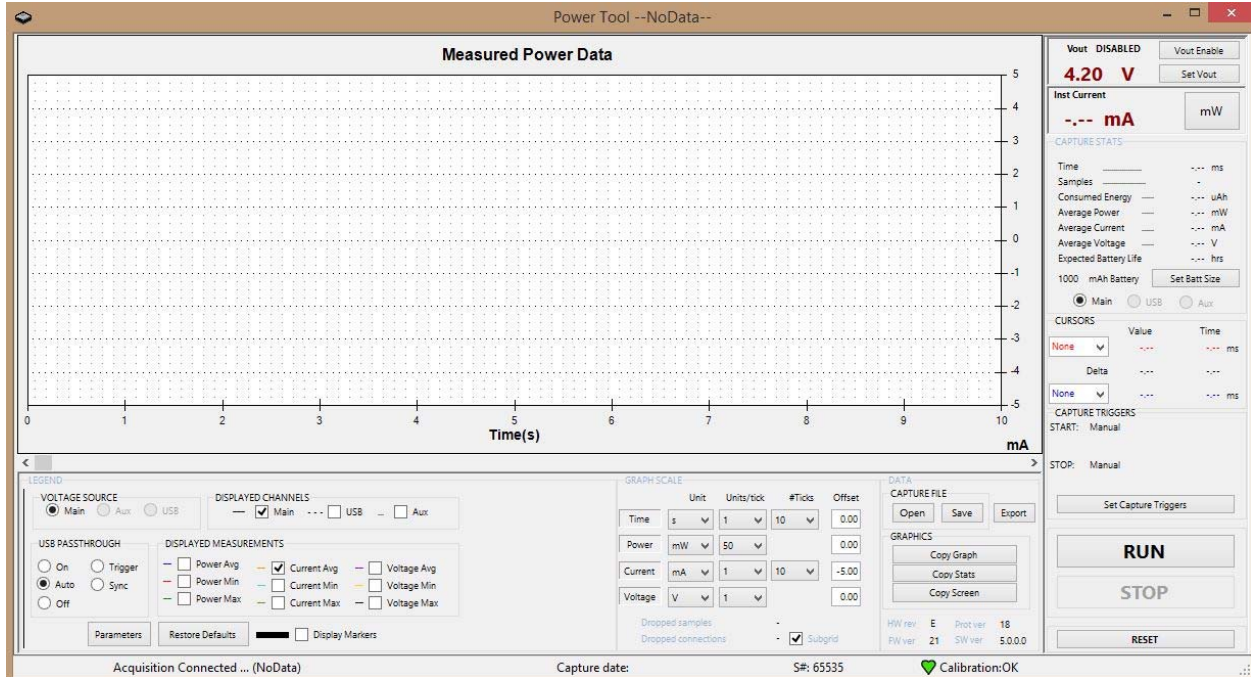

Figure 9 PowerTool software UI after connecting to a device

Checking the Software Revision of the Power Monitor

The revisions of the hardware (HW ver), firmware (FW ver), and software (SW ver) should be compatible for consistent and repeatable results and performance.

If the Power Monitor software is updated, the firmware will need to be confirmed for compatibility. The Power Monitor will prompt the user to indicate that a new firmware is required to run this revision of software. If this occurs, then the firmware (FW ver) will need to be updated on the Power Monitor. Please follow the [instructions on updating the Power Monitor firmware](#).

The following table describes the various revision numbers that are displayed in the UI.

Field	Description
HW rev	Power Monitor hardware revision
FW ver	Power Monitor firmware version
Prot ver	Version of protocol specification
SW ver	PowerTool UI version

HW rev	SW ver	Firmware Version
B, C, D	3.0.4	12
B, C, D	4.0.2, 4.0.1	17, 18
B, C, D	4.0.3	19
B, C, D	4.0.4	19, 20
F, E, G	5.0.0	21, 25, 27, 32

To make sure the correct software is installed, check the revision fields in the UI. Figure 10 below shows the area of the UI that displays the software revision.

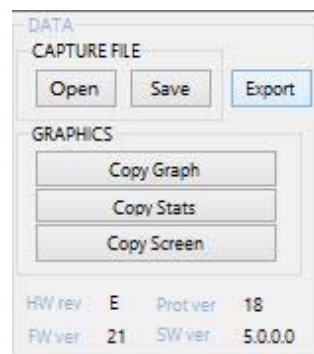

Figure 10 Revision fields shown in the PowerTool UI

Powering-up and Powering-down a Mobile Device

To power-up the device, first set the Vout voltage. The voltage can be set from 0.8 V to 13.5 V in .01 V increments.

To enable the power, click the **Vout Enable** button, to disable the power, click the **Vout Disable** button.

Figure 11 below shows the location of the Vout Enable, which toggles when it is clicked to the **Vout Disable** button.

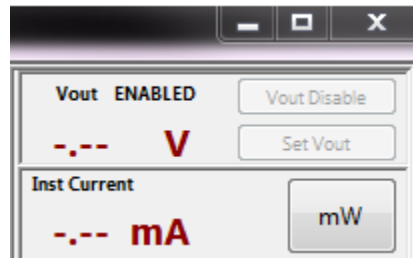

Figure 11 Vout Enable and Vout Disable button

The voltage at the red and black terminals is never exactly at the programmed voltage. This is because there is an internal 0.110Ω sense resistor in series with the regulator. For example, if the device is drawing 1 A when Vout equals 3 V, expect to see $(3 - 1 \cdot 0.110) = 2.890$ V. Figure 12 below shows this sense resistor in series with the regulator, in relation to the red and black terminals.

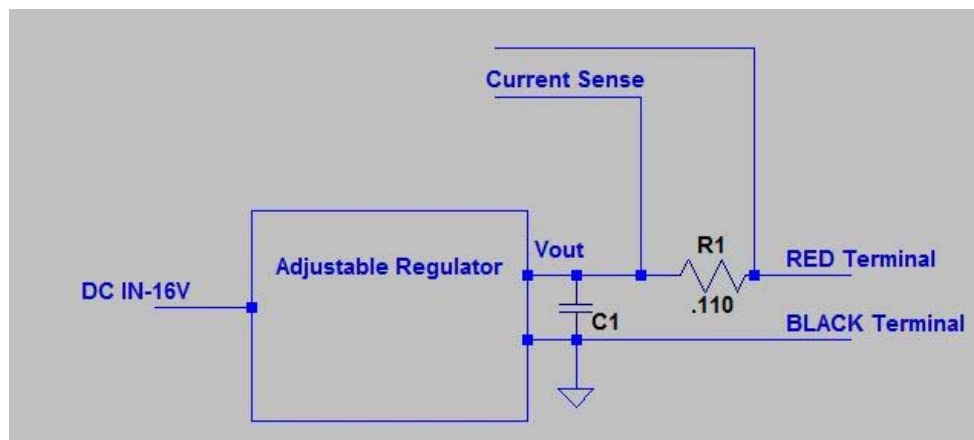

Figure 12 Sense resistor in series with the regulator, in relation to the red and black

There is resistance in the wiring that can lower the voltage at the device. The resistance of the wiring plus the sense resistor is similar to the resistance of the lithium battery in the device; batteries are usually about 0.12Ω .

The resistance of 20 gauge wire is $0.012 \Omega/\text{ft}$, so if the cables are 20 gauge, and 1 foot in length, that adds another 0.024Ω , in addition to the contact resistance.



Figure 13 Vout LED indicator

If the power-up is successful, the green Vout LED indicator in Figure 13 above will power-up. This LED is connected directly to Vout, so the light will dim slightly if the voltage is lowered. If this LED does not power-up, then Vout did not power-up properly, so there are other problems.

Low Battery Warning on Device

In some cases your device under test may give a lower battery charge warning or not power up. In those cases, increase the Vout value. This is particularly likely to be seen if a battery blank is being used instead of a lithium battery with a bypass.

Over-Current Error from the Main Power Supply

Sometimes an over-current error occurs when powering-up. When an over-current error occurs, the power LED displays as amber.

An over-current error can happen when the:

- Device is attached backwards.
- Device is attached incorrectly.
- Device has a lot of capacitance, a very high in-rush current.
- Device has an unusually high run current.



Figure 14 Amber LED indicator for over-current

Note Be sure to check for a backwards connection before overriding the over-current limits.

Protecting the Main Power Supply from an Over-Current Error

The main power regulator can source 6.0 A of continuous current. In order to protect incorrectly connected devices from damage, a carefully controlled power up sequence is used. The default sequence is as follows:

- Power up with no current limit for 20 milliseconds
- Run for 1 second with the current limit set to 500 mA
- Run continuously with the current limit set to 6 A

The parameters in the dialog box below are used for device under test power on.

- Power up time – This specifies the power up time when no current limit is applied to the Mobile Device Power Monitor.
- Power up Current Limit – If the Power Up Time is set to default, this parameter will allow the selected current to be supplied to the device for 20 ms.
- Run time Current Limit – This parameter specifies what the maximum current that can be sourced by the Mobile Device Power Monitor while it is sampling or in “Run” mode.

If a device does not power up with this default profile, the profile may be adjusted. Click on Parameters in the UI and the dialog box shown below in Figure 15.

The Set Parameters Dialog Box

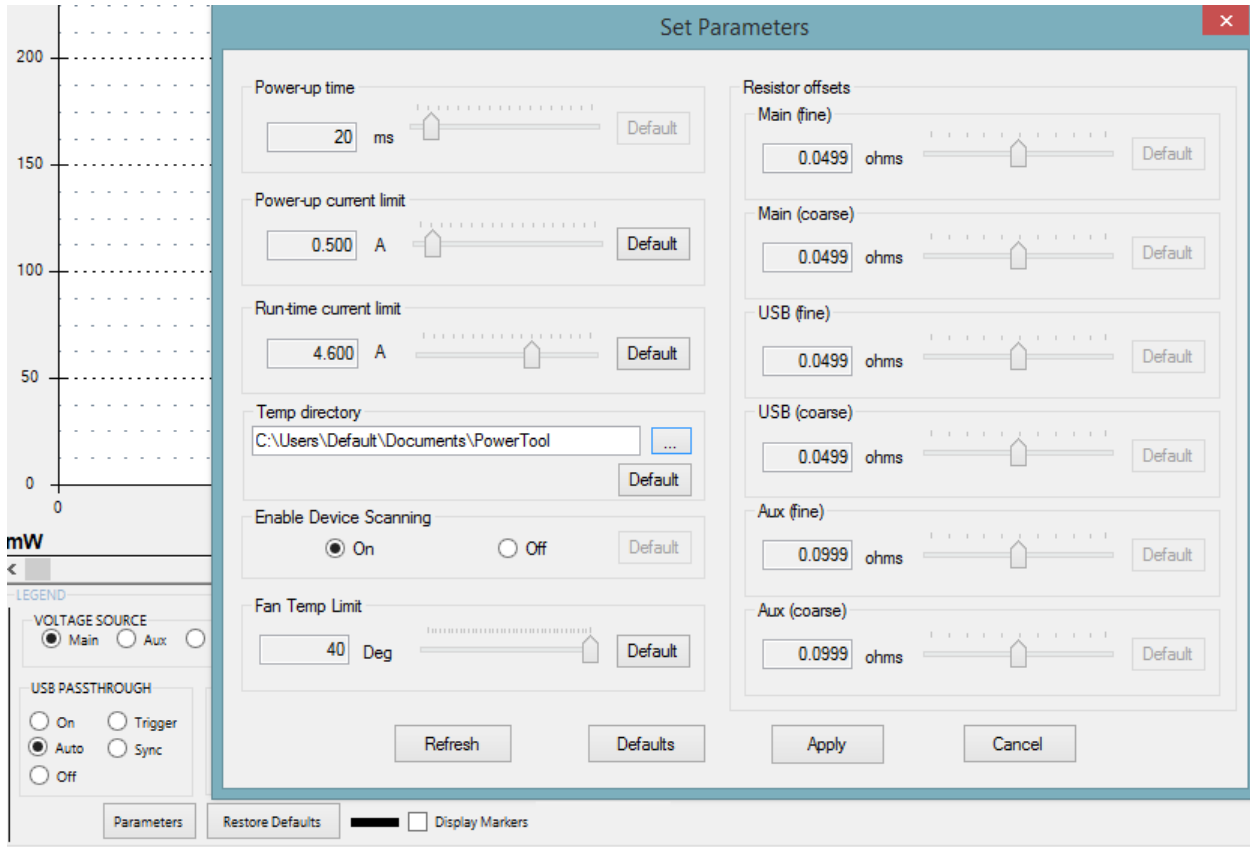

Figure 15 Dialog box for Set Parameters

In addition to changing the power-up and runtime current limits, you also can specify the temporary directory that will be used to store sample data and whether to automatically scan for Power Monitor device connection changes.

The Fan Temperature Limit cannot be altered in pre-5.0.0.0 release of the firmware, and the Resistor offset values have been deprecated in the 5.0.0.0 release.

The Legend Dialog Box

The Legend dialog box controls which channels are displayed, and what kind of data is shown in the graph, as well as the USB Passthrough Mode.

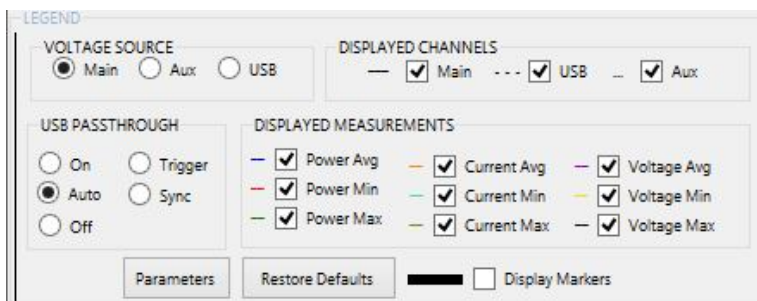

Figure 16 Dialog box for the display Legend

The Scale Dialog Box

The Scale dialog box controls how the data is displayed in the graph.

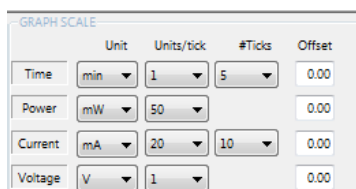

Figure 17 Dialog box for the display Scale

The time scale is always shown along the X axis. The Power, Current, and Voltage scales are shown along the Y axis depending on the data selected in the Legend dialog box.

The Unit dropdown lets you select the unit to be used for display.

The Units/tick dropdown specifies the granularity of each tick. For example, if you specify a unit of "min" and a units/tick of "2", there will be a tick for 2 minutes, 4 minutes, and so on. The smaller the number you select, the finer the granularity.

The #Ticks dropdown specifies the number of ticks to be displayed. The Units/tick multiplied by the #ticks will determine the range of data you will see on the graph at any given time.

The data that is displayed is calculated based on the granularity of the timescale you have chosen. If the full resolution of data sampled can be displayed in the UI, then instantaneous data will be plotted and Average, Min and Max values will all be identical, as there is nothing to smooth or average over.

If the timescale is such that a larger time range or larger granularity is chosen than can display the full amount of instantaneous data, the data will be averaged across adjacent samples at the smallest range possible. Max, Min, and Avg data is shown at a given point to capture the values of that range.

As you increase granularity, the Max/Min/Avg lines will converge and you'll ultimately have only one line. Similarly, as you decrease granularity, Max/Min/avg lines will be calculated and displayed.

The offset will shift the displayed portion of the graph along the axis. Both positive and negative numbers may be used.

IMPORTANT: Data is generated and stored in memory for each point drawn to the graph. If you plan to do an extended measurement (more than 12 hours), you should choose a timescale that is in minutes or hours and select a broader granularity to ensure efficient use of system memory. Additionally, if you choose a fine scale such as microseconds, expect a slower UI response time for other functions due to the resources required for such a high UI refresh rate.

Sampling Data

To begin sampling data, click the **Run** button. To stop sampling, press the **Stop** button. Figure 18 below shows the **Run** button, which toggles to the **Stop** button once it is clicked.



Figure 18 Run and Stop toggle button

The calibration indicator indicates that the unit has a valid and unexpired calibration date and functioning auto-calibration hardware. The heart will show green, yellow, or red, depending on how close we are within desired calibration tolerance. Temperature variation is the primary reason why the Power Monitor will go out of tolerance, though large, rapid changes in current consumed will also cause this.

A Green heart indicates the unit is in calibration, and measurements will be within the advertised accuracy of the Power Monitor. A yellow indicator indicates marginal calibration, and measurements will tend to be accurate to within +/- 5%, rather than 1%. A red indicator means measurements will be within +/- 10%, and may be off even further if the indicator remains red for more than about 30 seconds.

Figure 19 below shows the calibration indicator.

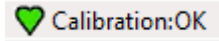

Figure 19 Calibration indicator

The serial number displayed in the UI, and shown in Figure 20 below, is the serial number of the Power Monitor hardware. It is programmed to a unique number in the factory. If the firmware is upgraded improperly in the field, the factory serial number may be incorrect. If this happens, it is advisable to contact Monsoon Solutions, Inc., because the factory calibration settings may have also been lost.



Figure 20 Serial Number

If more than one Power Monitor is connected to your computer, a dropdown arrow will be displayed next to the serial number to let you switch which Power Monitor you are currently connected to for sampling. The Power Tool GUI establishes a connection to only one Power Monitor at a time, so if you switch which Power Monitor you are connected to, you will be asked if you want to save your current data. Similarly, a given Power Monitor may only be accessed by one PowerTool instance at a time. If you are running multiple instances of the PowerTool software, and another instance has already connected to a given Power Monitor, it will not be available in your list of serial numbers to select.

If you are running with 'Enable Device Scanning' OFF, the serial number will be greyed out and you will not be able to change which Power Monitor you are attached to.

Power Monitor Reset

A reset button is available to cycle the power to the Power Monitor unit itself. The reset operation is equivalent to cycling the power button in the front of your Power Monitor. This can be used if your computer loses its connection to the Power Monitor device or if you want to cycle the hardware for any reason. Be aware, the Power Tool GUI will lose its connection to the Power Monitor device and will be prompted by the Power Tool UI to re-establish the connection.



Figure 21 Reset button

Cursors

Cursors enable users to measure the delta (Time and selected data channel) between two points on the power monitor output data plot.

1. Drag the red and blue arrows (indicator) to the desired position on the power monitor output data plot, as shown in Figure 22 below.
2. The Delta will be displayed under the Selection Statistics section.

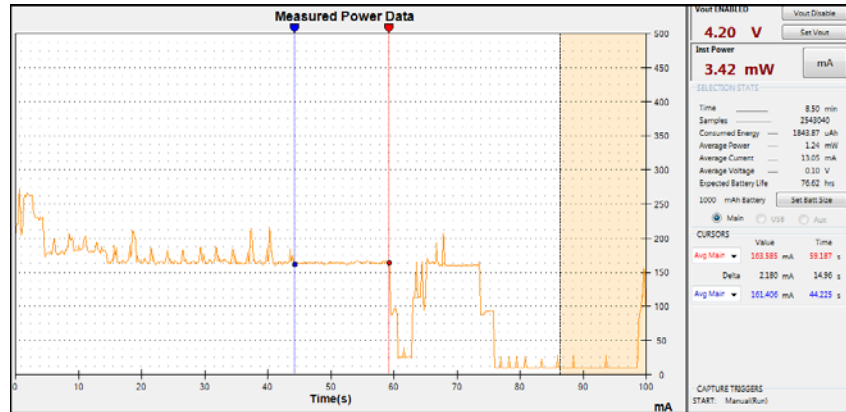

Figure 22 Selection Stats

Statistics

Battery life, current, and power statistics for the selected channel are visible in the STATS area of the UI. In order to get correct values for Expected Battery Life, the user should be sure to set the Battery Size before the run. If there is no region selected, the statistics will be associated with the entire run as in Figure 23 below.

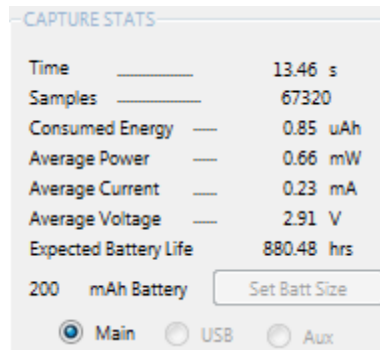

Figure 23 Capture Statistics

Whereas the graph shows average data base on the timescale, the Capture Statistics region provides averages over the entire sampling run as well as instantaneous values for the run. Average power is derived from instantaneous current and voltage, and then averaged over the duration of the sampling run. Instantaneous voltage is shown for Vout. Instantaneous Current and Power can be viewed by toggling between mA and MW button, as shown below. In addition, if multiple channels are being measured at once, the user can toggle between those channels.

If a smaller area is selected with the mouse on the graph, then the statistics are computed only for the selected area, as shown in Figure 24 below.

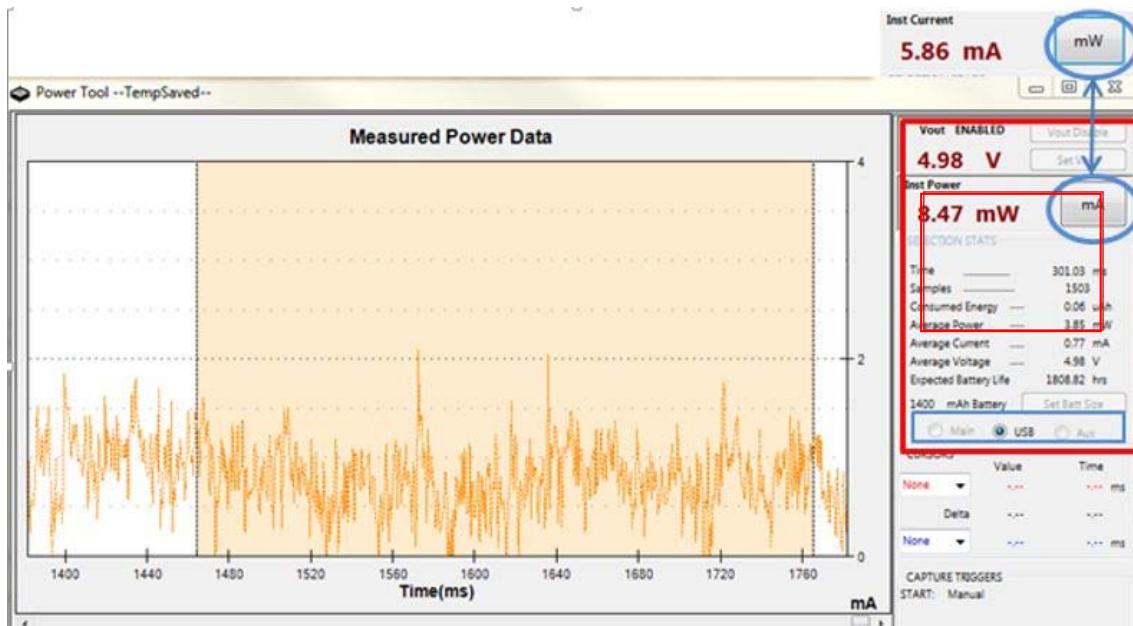

Figure 24 Selection Statistics

Zoom

Selecting a certain area with the mouse on the graph and by either double clicking or selecting the scroll mechanism on a mouse (if one is available) will zoom in on the selected area. Note, even though the screen is not updating during this time, sampling is still occurring in the background. The statistics are computed only for the selected area, as shown in Figure 25 below. When you are done looking at this area, press ESC, and the screen will refresh and return to displaying data as it is sampled.

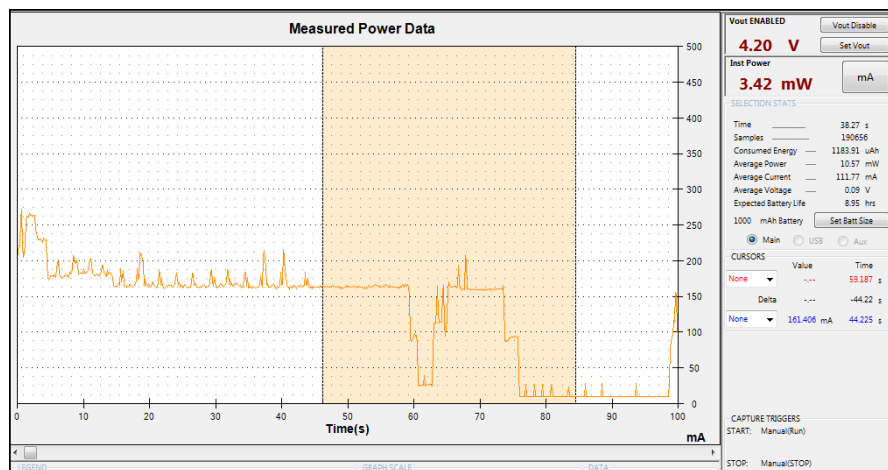

Figure 25 Zoom Capability

Triggers

Triggers can be set to start and stop sampling based on specified criteria. Your current trigger setting is shown in the main Power Tool GUI right above the Set Capture Triggers button, as shown in Figure 26 below. By default, the setting is Manual.

To open the trigger configuration dialog, select the “Set Capture Triggers” button.

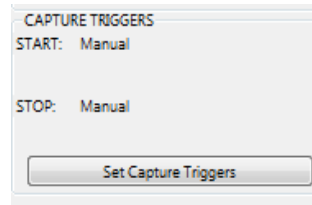

Figure 26 Capture Triggers

You will then be able to specify both start and stop conditions.

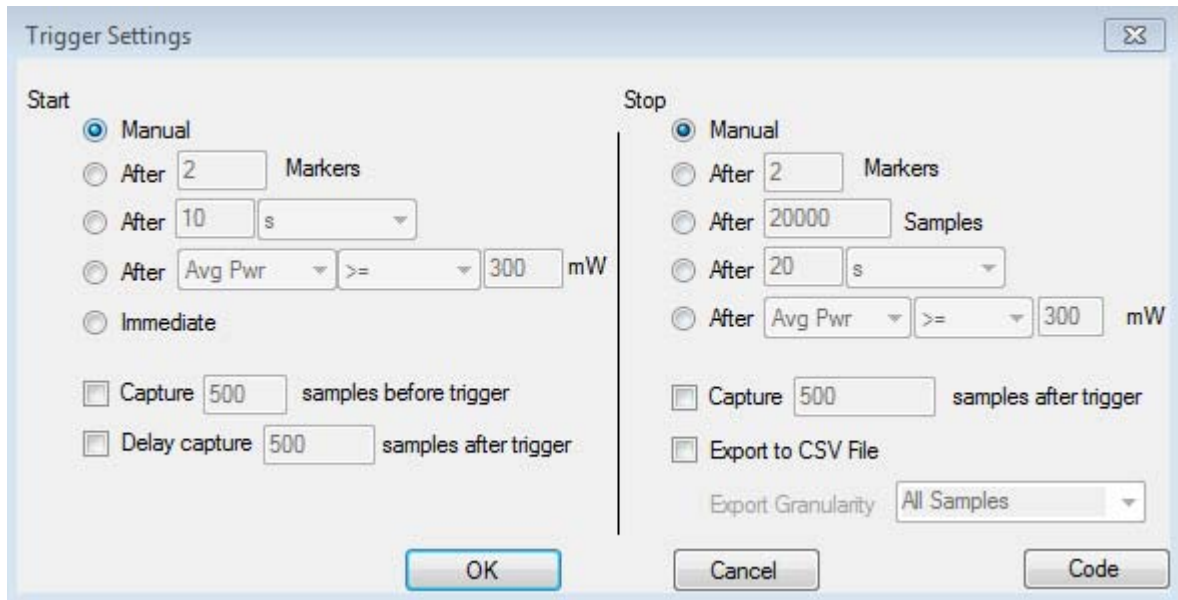

Figure 27 Trigger Settings Dialog

Important Notes:

If you specify to capture samples before a start trigger and the start condition is such that there aren't that many samples available before the trigger, your data will only contain the number available.

If you delay capture too many samples after your start trigger, and your stop trigger condition matches, you may not get any samples in your data.

Triggers are evaluated as batches of samples are processed, so the stop and start times will vary within a fraction of a second of the specified time.

Trigger settings are saved in your .ini file and will be preserved in your next session.

Once you have saved your settings, you will see your choices reflected in the text on the Power Tool GUI. You must still select RUN and then the trigger conditions will start evaluating.

USB Measurements

In addition to the Main channel, two other channels are available to do sampling. One of these is used for monitoring USB power and current draw. To use the USB channel, connect the USB device to the front of Mobile Device Power Monitor, and connect an additional USB cable from the front of Mobile Device Power Monitor to the development workstation as shown in Figure 28 below. In most cases, you will still need to keep the main channel connected and enabled as well. This will be discussed further below.



Figure 28 USB device connection, including main channel connection

There are 3 primary modes when using the USB Channel. USB ON, OFF, and AUTO. For people using active devices such as phones, most will want to use AUTO.

- **Auto:** Setting the **USB passthrough mode** to **Auto** enables a USB connection from your device to the computer which allows you to download files, configure test programs, charge the device, etc. Once sampling is started, the direct USB connection is disabled, charging over USB is disabled, and samples are measured without the interference of USB charging. As soon as sampling is stopped, the direct USB connection is re-enabled and data can once again be transferred to and from the device over USB. A main channel connection with Vout enabled is required in this setting.
- **On:** Setting the **USB passthrough mode** to **On** enables the USB connection and records the current flowing through the USB connector on the front of the Mobile Device Power Monitor. The main channel connection is not required when using this configuration as power is provided through USB. *Note, the main channel Vout should still be enabled to ensure proper readings.*
- **Off:** Setting the **USB passthrough mode** to **Off** disables the USB connection. The main channel connection with Vout enabled is required in this setting.

The USB passthrough mode is set by selecting Parameters, and then specifying the desired mode.

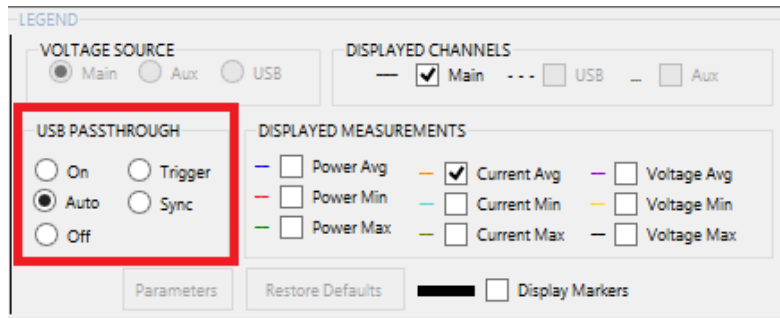

Figure 29 USB pass-through control

Depending on your device and use case, there are different configurations you will want to use.

Measuring Power

Battery powered device, either with a battery blank or bypassed battery (mobile phone, etc.)

- USB A cable connected from front of power monitor to device.
- USB B cable connected from front of power monitor to computer.
- USB Passthrough = AUTO
- Main channel is connected and powered (Vout enabled)
- USB channel selected for display

In this configuration, the state is equivalent to having USB Passthrough=ON before you start sampling. You can communicate with your device under test, send data, etc. As soon as you start sampling, it is equivalent to USB Passthrough=OFF. All current being provided to the device is from the power monitor main channel and no USB current is provided. Once sampling is completed, the state is equivalent to USB Passthrough=ON and the device under test is once again accessible from your computer and data may be uploaded and analyzed.

USB powered device (mouse, keyboard, etc.)

- USB A cable connected from front of power monitor to device.
- USB B cable connected from front of power monitor to computer.
- USB Passthrough= ON
- Main channel is not connected, but is powered (Vout enabled)
- USB channel selected for display.



Figure 30 USB powered device

Measuring charging current

Battery powered device with active battery and connected to wall charger

- USB A cable connected from front of power monitor to device.
- USB B cable connected to DCP (dedicated charging peripheral) wall charger. **This charger must NOT provide more than 1 amp or you will risk destroying your power monitor.**
- USB Passthrough= ON
- Main channel is not connected, but is powered (Vout enabled)
- USB channel selected for display.

In this configuration you can measure how much current your device is pulling while charging. This allows you to verify a charger is able to deliver the rated amount of current, up to 1 amp.

Battery powered device with active battery and connected to computer

- USB A cable connected from front of power monitor to device.
- USB B cable connected to computer
- USB Passthrough= ON
- Main channel is not connected, but is powered (Vout enabled)
- USB channel selected for display.

In this configuration you can verify that your device is only pulling $\leq 500\text{mA}$ when connected to a PC, per USB specifications.

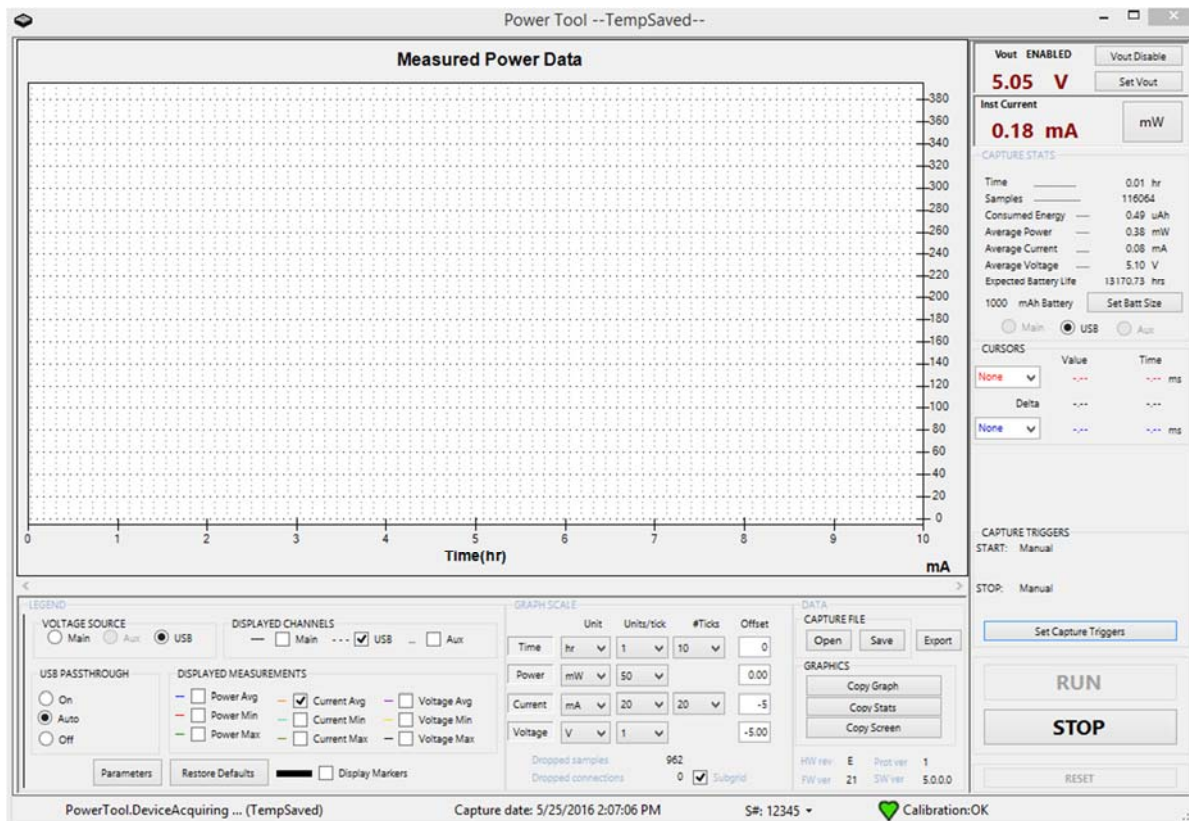

Figure 31 PowerTool with USB set in the Legend box and in the Capture Stats box

Auxiliary Port (Aux)

The Aux port is accessed via the bayonet Neill-Concelman (BNC) connector on the front of the Mobile Device Power Monitor. The Aux port allows you to isolate current measurements across a sense resistor.

Note, for Aux measurements, the MAIN channel must always be powered (Vout enabled) even though it is not being used for measurements or to power the device under test.

Calibrating the Aux Channel

Unlike the Main and USB channels, the AUX channel has only preliminary calibration, and must be user calibrated prior to taking any measurements. This requirement is due to the dependency of measurements on your specific cables, sense resistor, and configuration.

We recommend that you go out from the sense resistor (+) to the load (+), then load (-) to Power Monitor Main (-), then Power Monitor Main (+) to Sense Resistor (-). This places the sense resistor load in line with the power monitor main channel which is far more precise. We recommend a 4.0V output from the Power Monitor with a 40Ω load. That *should* yield exactly 100mA mathematically [$I=V/R$], but doesn't take into account lead resistances, sloppy tolerances, etc. The calibration process will zero out these interfering resistances.

Figure 32 shows the Power Monitor when wired for calibration (This is using a precision adjustable load of 40Ω as the "load", and the Power Monitor's Main Channel is the Power Source). Note the .1 ohm sense resistor across the aux channels, as shown in Figure 33. You should use the same wires for calibration that you plan to use for actual measurement, to ensure you are accounting for all system resistance.

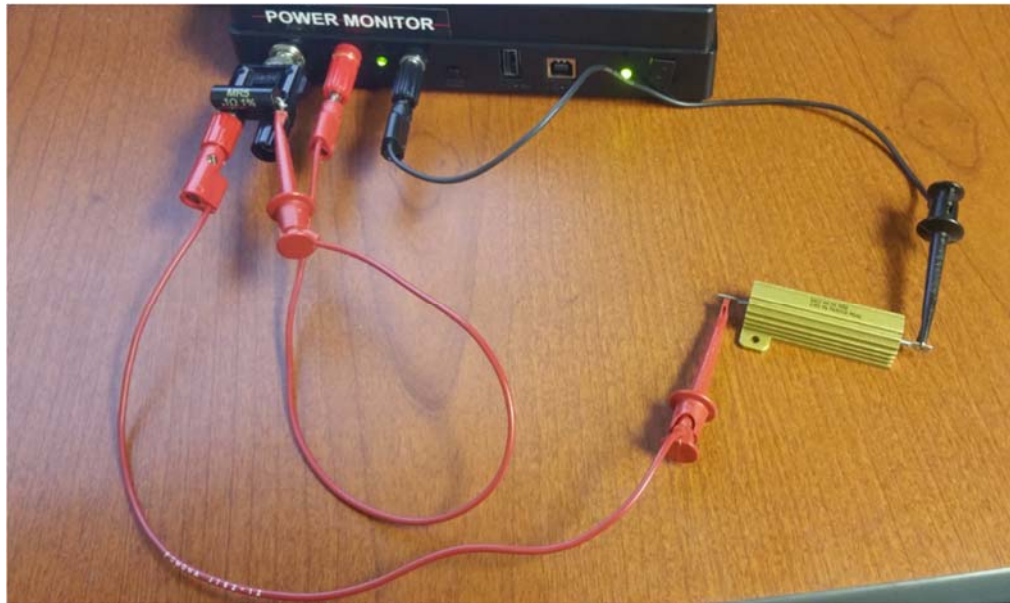

Figure 32 AUX Calibration



Figure 33 0.1 ohm sense resistor

You can use any resistor that will produce the appropriate current you're intending to measure, just make sure you know the exact value of the load resistor.

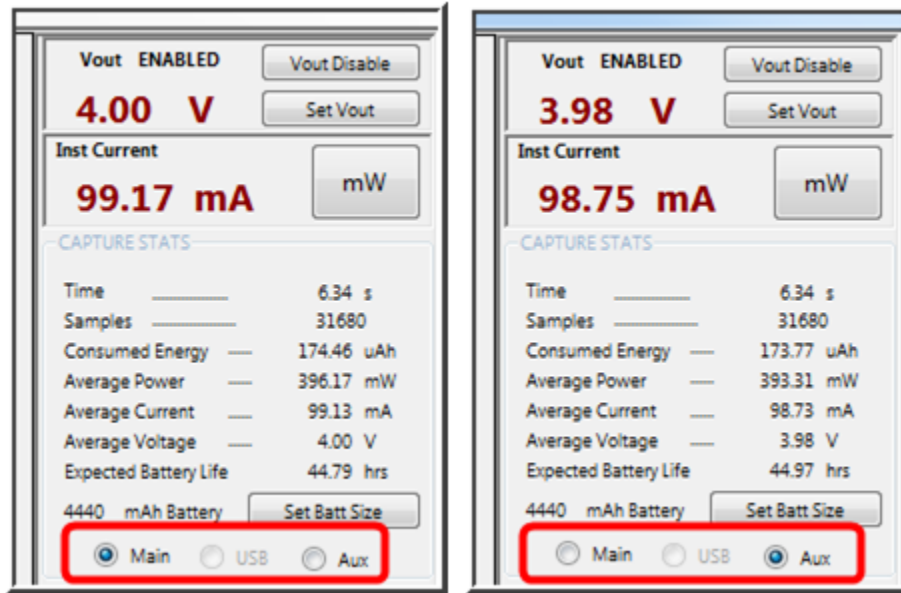

Figure 34 Comparing Aux and Main current

Open the software in config mode by running from the command line:
 "PowerTool.exe -config."

The 'config' button will appear in the main GUI. Pressing it will cause the following window to appear:

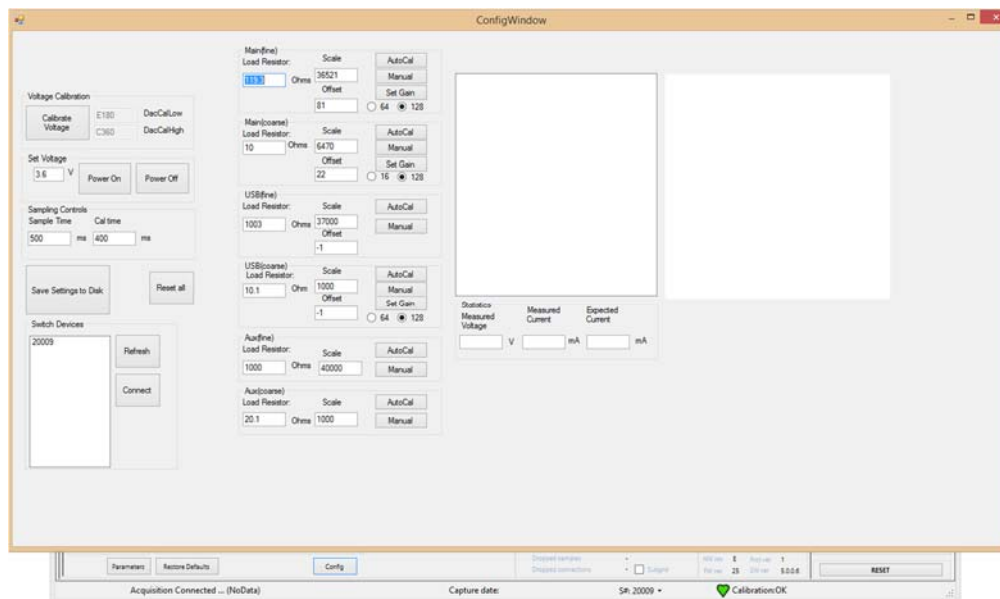

Figure 35: Config Window

Perform the following steps:

1. Input the value of the load resistor you're using to the appropriate load resistor box. In this case the Aux(fine) and Aux(coarse) boxes.
2. Enter the Set Voltage appropriate to your use case, and press 'Power On.' The Power Monitor should be within tolerance across its entire voltage range, but it will be most accurate at the specific voltage it was calibrated at.
3. Press 'AutoCal' – this will run the autocalibration algorithm to select the appropriate scaling value.
4. Press 'Manual' on the appropriate channel to conduct a sampling run. Statistics will be shown in the sampling windows, including the measured voltage, measured current, and the current that would have been expected, given the voltage and resistance of the load resistor.
5. A histogram of the distribution of samples will appear on the graph to the right side of the screen. Green bars indicate the samples are within tolerance, while red bars indicate samples out of tolerance. A histogram that is off-center indicates the need for recalibration or manual adjustment, while a histogram with red bars on both sides indicates no additional calibration will result in more accurate measurements.

The Aux channel is calibrated at the factory to expect a sense resistor of 0.100 ohms, but any sense resistor could conceivably be used. Smaller resistors result in a larger measurement range, but reduced accuracy. Larger resistors result in the reverse.

Isolating current draw measurements at a specific point in a circuit in the device under test

Suppose the LT1129 shown below in Figure 36 sits on a mobile device PCB and the current supplied to the 3.3 V supply needs to be measured.

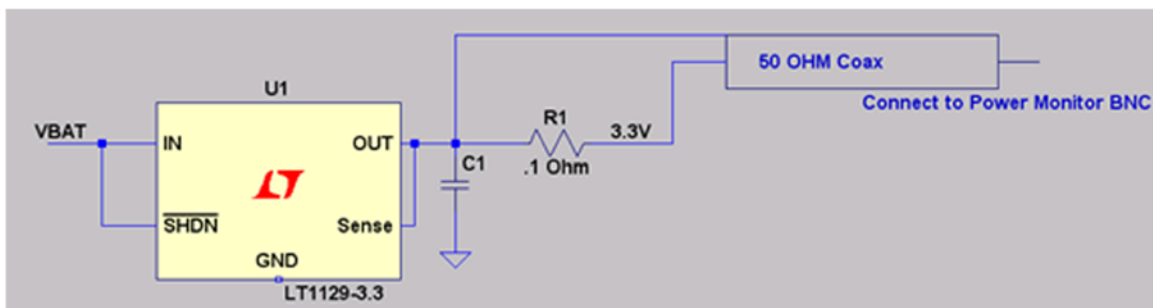

Figure 36 Schematic of the Aux port connection

In this situation, to measure the current supplied to the 3.3 V power supply, connect a 50 Ω coaxial cable to a 0.1 Ω sense resistor and connect that coaxial cable to the Mobile Device Power Monitor. When connecting a coaxial cable:

- Connect the outside of the BNC connector to the high side of the sense resistor.
- Connect the inside of the BNC connector to the low side of the sense resistor.
- Enable Vout

In Figure 37 below, the mobile device is powered by the Mobile Device Power Monitor and its processor core power is being monitored on the Aux port with a 0.1 Ω resistor. In the Mobile Device Power Monitor, the data for the main supply and the core supply can be displayed and analyzed simultaneously.



Figure 37 Example connection to the Aux port

Measuring battery drain while device under test is exercised

The Aux channel is the only way to use the Power Monitor to measure battery drain. All other channels bypass the battery.

The configuration is very similar to the case above, except that the 0.1 ohm sense resistor should be in-line with the battery.

Data Importing Features of the Power Monitor

The data importing features of the Power Monitor allows the user to import data from the following data formats:

The PowerTool software can import the file formats shown in the following table.

File format	Description
.PT5	Binary data in exactly the same format that the Power Monitor creates for internal processing; this is compatible with the current version of the protocol specification. Please see the APPENDIX for a more detailed breakdown of the PT5 format. Update from PT4 to PT5 moves from 16-bit to 32-bit measurements in order to support more precision in the microamp range.
.PT4	<i>Deprecated.</i> Older export format, will be converted into PT5 format before displaying
.PT3	<i>Deprecated.</i> Older export format. Will be converted to a PT5 format before displaying.

The PT4 file format, when saved, contains data at the maximum time resolution, regardless of the Capture Settings. Thus, when you read this file format in, you will have the full set of data from your recorded session.

Data Exporting Features of the Power Monitor

The data exporting features of the Power Monitor allows the user to save or export data for the following:

- The entire power measurement run
- Data selected and highlighted
- Data currently displayed on the screen.
- In the case of CSV, the granularity you specify exported

When you **SAVE** data, it will save in a PT5 format and will save all field data at the maximum time resolution, regardless of the capture settings or what is displayed on the screen. A PT5 index file (.CD5) will also be saved to optimize the process of recreating the graphical display data when you re-import the PT5.

When you **EXPORT** data, it can be exported in the file formats shown below. You will have the option to select to export only the highlighted or displayed region, or all data sampled.

File format	Description
.PT5	Binary data in exactly the same format that the Power Monitor creates for internal processing; this is compatible with the current version of the protocol specification. Please see the APPENDIX for a more detailed breakdown of the PT5 format
.PT4	Deprecated file format, intended for customers who have automation software already written using .pt4 files.
.CSV	Comma-separate values. A common format that can be used to import into spreadsheet software. The units saved are those specified in the graphical display settings.

The data is exported at the full resolution of the sampling run, but only for the range specified.

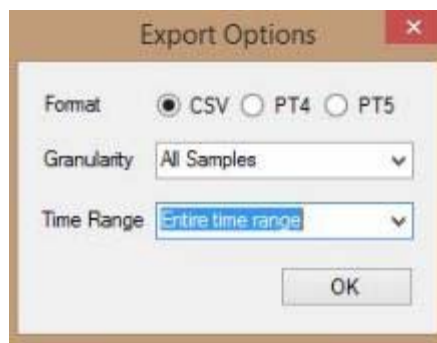

Figure 38 Time Range Export Dialog

PT5 export details

When you specify a subset of data to be exported to PT5, the sampling start time will be adjusted to take into account the start time for the selected region. The sample time shown for the samples will start at time 0 from that point. All data for all sampled channels will be saved in the pt5 file, regardless of UI settings chosen.

CSV export details

In the case of CSV, you may specify a granularity for export. The available options are all records, or every 10th, 100th, 1000th, or 10,000th records. Data is not averaged, rather only the specified subset of samples chosen will be exported, resulting in a lower effective sample rate. Data will be exported to CSV for any field that is selected for display in the graph. When you export a subset of data to CSV, your start time will reflect the offset from the start of your run.

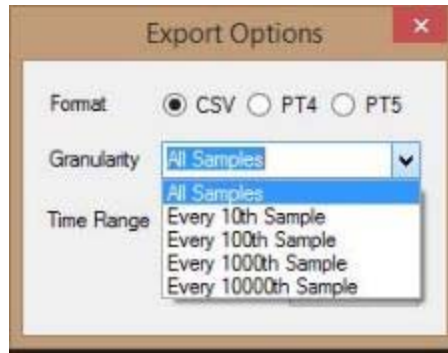

Figure 39 CSV Granularity Export Dialog

Note. If you want the PT5 format, unless you want to limit the range of data saved, we recommend you **SAVE** vs. **EXPORT**, as it is a much more efficient process.

Functional Description of the Power Monitor

To measure the current accurately, a dual range, self-calibrating, integrating system is used. Each channel has two current ranges with a 16-bit analog-to-digital converter (ADC), one with a high-resolution range, and the other with a low-resolution range. Software continuously calibrates each of these and selects the proper range during measurement.

The dual range scheme works because mobile devices are usually in standby mode and drawing only a few milliamps of current, or they are running above 100 milliamps. The Power Monitor must be very accurate when the current is low, but may be less accurate as the current increases. Each sample is integrated over its 200-microsecond sample period so that even a brief high-current pulse is captured. Depending on system capacitance and other factors, the fastest transient pulses are around 20 microseconds. The integrator sums up these fast pulses so that an accurate assessment of the average current is maintained. The unit is self-calibrating. One cycle out of every 1000 cycles is used to run either a zero-current calibration or a reference-current calibration. Software uses these measurements to null out the offset and gain errors in the system. Because this is done automatically, it compensates for slow temperature changes during the measurement run.

The scale used by the Power Monitor is adjusted during factory calibration, and can be user-adjusted using Configuration Window. The Power Monitor has an overflow buffer that can hold 16 packets of 64 bytes each. During transfer, if the development workstation cannot read the data fast enough then this buffer will begin to fill up, and samples may be lost. The received data is concatenated so the line appears continuous. To account for the lost samples, the protocol contains a 16-bit counter that tracks the number of lost samples. The running total of lost samples is displayed in the UI, as shown in Figure 40 below.

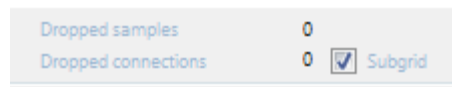

Figure 40 Dropped Samples

Because the dropped samples are less than one percent of a run, the error is minimal. Usually this loss of data is less than 0.1 percent. However, sometimes on long runs or on loaded systems the dropped sample count can exceed 65,000. When this occurs, or when

the PowerTool lost communication for more than 10 second, the connection is considered dropped. A count of dropped connections is maintained in the UI, as shown above in Figure 40. Both of these counts are reset to zero when a run is restarted. These counts are useful to determine how stable the connection is. If the dropped packets are greater than one percent of all samples, or if there are more than one or two dropped connections per hour, then it is likely that the development workstation has other applications running that are causing delays. Closing these applications or installing the PowerTool software on a clean machine should solve these issues and reduce the dropped samples and packets.

APPENDIX:

Frequently Asked Questions

Do you provide Linux or Mac support?

The Power Monitor is specifically designed for the Microsoft Windows operating system and relies on custom device drivers only available for Windows. We are not presently looking at a solution that will run natively on Linux or Mac. We understand some users have environments that are primarily Linux or Mac. The following are our recommendations.

Fully supported:

Option 1: Setup a windows machine with the power monitor software, .Net and a webserver. Write a simple webserver wrapper using the Power Monitor API. Expose this webservice as desired, and call it from within your Linux or Mac environment. You will connect your power monitor device(s) to the windows machine and control them remotely through your Linux environment over the webservice. This is the most robust and flexible method to complete integration for automated testing, especially if you need real-time access to data while the sampling is running.

Option 2: Setup a windows machine with the power monitor software and .Net. Write a script in any desired scripting language that will execute PowerToolCmd command line calls. Open ports to exec these calls remotely from your Linux/Mac environment. This method works well if you don't want to add a webservice wrapper and simply need the output of a power monitor run, but don't need to access any data during the run.

Not fully supported, but reported as successful. We do not test or provide technical support for this configuration.

Option 1: Setup a virtual machine with a supported Windows Operating system, and host that virtual machine from your Linux or Mac environment. Install the power monitor software and drivers on the virtual machine. Attach the power monitor device(s) directly to your Linux/Mac host and access them via the Virtual Machine.

Do you provide higher or lower voltage support?

Monsoon has two Power Monitor Products. The LVPM version of the hardware supports a voltage range of 2.01-4.55V in 0.01V increments. This version of the product will no longer actively be sold by Monsoon Solutions once present supplies are exhausted.

The current HVPM version of the hardware supports a voltage range from 0.8-13.5V in 0.01V increments.

There is an experimental method in the Appendix under the heading '[Connecting an external supply in series with the main channel!](#)' which provides instructions that will allow users to exceed the voltage limits of the Power Monitor using an external supply.

How do I test whether my unit is still in calibration?

If you are using the 5.X.X.X version of the software, and are using a High Voltage Power Monitor, we have created a configuration window that allows you to more closely examine the individual samples collected by the Power Monitor.

If you suspect your unit may be out of calibration, it will be worthwhile to test the unit's calibration. For this procedure, you will need two resistors of precisely known value (we recommend a 40-ohm and 120-ohm resistor), and you will need to run the PowerTool application with the "-config" flag in order to access the configuration menu. The easiest way to do this is to right click the application, select "create shortcut," and add the -config flag to the end of the Target field:

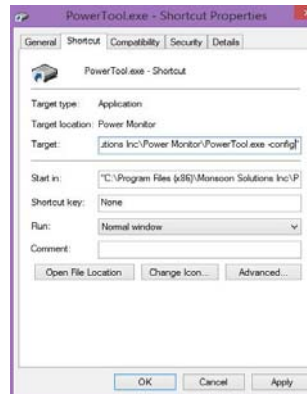

Figure 41 PowerTool.exe -config shortcut

This will make available the button to select configuration mode:

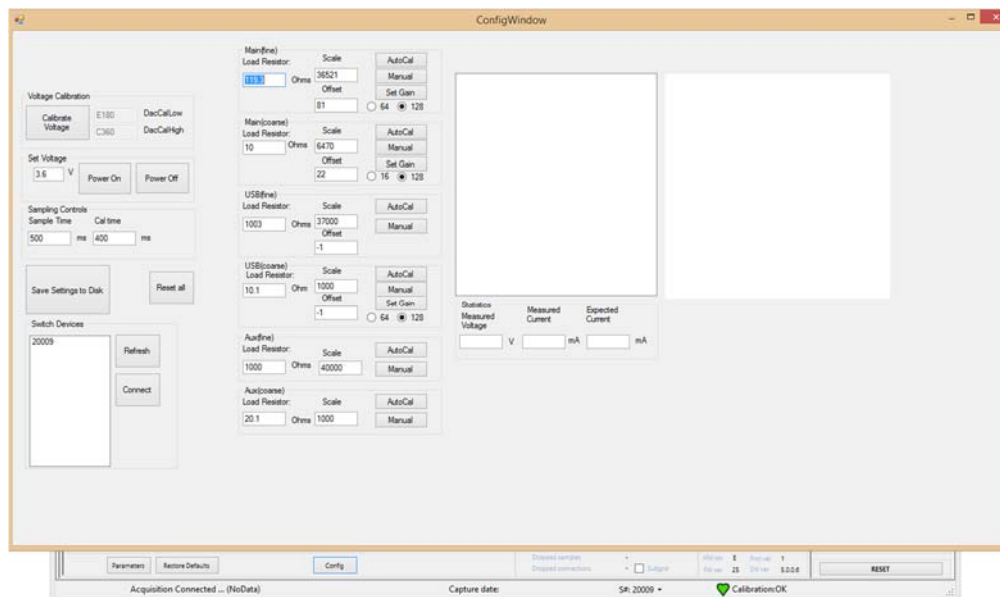

Figure 42 Configuration Menu

Perform the following steps:

6. Input the value of the load resistor you're using to the appropriate load resistor box. Most users will be interested in the Main Channel, which corresponds to the black and red banana jacks on the front of the Power Monitor. The Main(fine) channel supports 0-60 mA, and the Main(coarse) channel supports 60mA-6A.

7. Enter the Set Voltage appropriate to your use case, and press 'Power On.' The Power Monitor should be within tolerance across its entire voltage range, but it will be most accurate at the specific voltage it was calibrated at.
8. Press 'AutoCal' – this will run the autocalibration algorithm to select the appropriate scaling value.
9. Press 'Manual' on the appropriate channel to conduct a sampling run. Statistics will be shown in the sampling windows, including the measured voltage, measured current, and the current that would have been expected, given the voltage and resistance of the load resistor.
10. A histogram of the distribution of samples will appear on the graph to the right side of the screen. Green bars indicate the samples are within tolerance, while red bars indicate samples out of tolerance. A histogram that is off-center needs to be re-calibrated, while a histogram that is centered and still contains red bars indicates a hardware issue.

Configuration Window Special Fields

Calibrate Voltage: This adjusts the Power Monitor's voltage setpoint tracking. Use this command if there is a large difference between the value you select in the UI, and the voltage actually output by the Power Monitor.

Set Voltage: These controls enable you to set the output voltage within a range of 0.8 – 13.5V

Sampling Controls: Sample time adjusts how many samples are requested during sample time. Cal time adjusts how often reference samples are requested instead of regular samples. These values solely affect the Configuration window, and will not carry over to the main UI.

Channel boxes: These controls enable the calibration of individual channels. The Channel box controls function as follows:

Autocal: Adjusts the current scaling based on the voltage output and the value of the load resistor that has been entered into the load resistor text box. The scaling value has a direct linear relationship to the current reported. I.E. if measurements have been 3% too high on your unit before calibration, you should expect to see a 3% decrease in the scale value, and perfectly aligned measurements thereafter. The algorithm does not automatically loop until convergence, and may require multiple presses.

Manual: Takes measurements without automatically adjusting the scale. Useful to test the current calibration of the unit.

Set Gain: On second thought, this should be a factory-only setting.

Offset: Some units will have a small positive or negative offset when measuring what should be 0 amps. This manually adjusts the 0-point of the Power Monitor's measurement to compensate for that offset. Typically it will be very small, in the range of -50 to 50. This value does not directly translate into current or amps, and represents a pre-scaling adjustment to ADC counts.

Measured Voltage: Is the average of all voltage measurements received.

Measured Current: Is the average of all current measurements received.

Expected Current: Is the current predicted by putting the measured voltage and load resistor into ohm's law ($V=IR$) to calculate how much current the Power Monitor should be measuring.

Ratings

Absolute Maximum ratings:

The Power Monitor is designed to work with a Class I Power Supply rated at 16V, 7.5A. Stresses above those listed under Absolute Maximum Ratings may cause permanent damage to the Power Monitor.

Absolute Maximum Ratings		
Parameter	Value	Unit
Supply Voltage	17.6	V
Supply Current	7.5	A

Environmental Conditions:

Environmental Conditions				
Parameter	Min	Optimal	Maximum	Unit
Operating Temperature	5	25	40	C
Storage Temperature	-20	25	80	C
Relative Humidity (operating)	20	30	80	%
Relative Humidity (storage)	10	30	90	%

Optimal environmental conditions represent the conditions Power Monitor units are calibrated under at the factory. The Power Monitor is designed for indoor use only. The Power Monitor is not designed for exposure to liquids other than being cleaned with Isopropyl alcohol as described in the cleaning instructions in this manual.

Electrical Specifications of the High Voltage Power Monitor

Main Channel

Component	Minimum	Maximum
Output voltage range	0.8 V	13.5 V
Continuous current		6.0 A
Integrator cutoff frequency	300 kHz	
Fine current scale - range		60 mA
Fine current scale - resolution	0.9 μ A	
Fine current scale - accuracy	+/- 1% or +/- 50 μ A (whichever is greater)	
Coarse current scale - range	60 mA	6.0A
Coarse current scale - resolution	125 μ A	
Coarse current scale - accuracy	+/- 1% or +/- 1 mA (whichever is greater)	
Programmable current limit range	8 mA	15.625 A
Programmable current limit accuracy	(0.7) * (current limit)	(1.4) * (current limit)
PTC trip limit at 16 V DCIN	Not applicable	14 A
Fan turn on temperature	1C	60C
Fan turn off temperature	Fan turn on setpoint - 5	
Thermal limit shutdown		75 C

USB Channel

Component	Min	Max
Input voltage range	2.1 V	5.4 V
Continuous current		0.8 A
Integrator cutoff frequency	300 kHz	
Fine current scale - range	50 μ A	40 mA
Fine current scale - resolution	+/- 1% or +/- 50 μ A (whichever is greater)	
Fine current scale - accuracy	30 mA	1 A
Coarse current scale - range	286 μ A	
Coarse current scale - resolution	+/- 1% or +/- 1 mA (whichever is greater)	
Coarse current scale - accuracy	0.52 A	0.85 A
VBUS PTC current hold limit	1.04 A	1.7 A
VBUS PTC current trip limit	22 μ F +/- 20%	

Auxiliary Channel

Note: Hardware rev G supports a maximum voltage of 13V through the Aux channel. **Power Monitors with hardware rev F and earlier will be damaged at any voltage higher than 5.5V through the Aux channel and require repair.**

Component	Min	Max
Input voltage range	0.5 V	5.5 V
Differential input voltage		0.1 V
Integrator cutoff frequency	300 kHz	
Fine current scale - range	0 mA	12 mA
Fine current scale - resolution	2.58 uA	
Fine current scale - accuracy	+/- 1% or +/- 50 uA (whichever is greater)	
Coarse current scale - range	10 mA	500 mA @ $V_{in} = 1V$ 1 A @ $V_{in} = 1.8 V$
Coarse current scale - resolution	100 uA	
Coarse current scale - accuracy	+/- 1% or +/-1mA (whichever is greater)	
Aux + side capacitance	22uF +/- 20%	
Aux + side input current	Not applicable	1% of 0.1 Ω resistor current

Electrical Specifications of the Low Voltage Power Monitor

Main Channel

Component	Minimum	Maximum
Output voltage range	2.01V	4.55V
Continuous current		3.0A
Instant Current		4.5A
Integrator cutoff frequency	300 kHz	
Fine current scale - range		40 mA
Fine current scale – resolution	2.86 uA	
Fine current scale - accuracy	+/- 1% or +/- 50 uA (whichever is greater)	
Coarse current scale - range	40 mA	4.5 A
Coarse current scale - resolution	286 uA	
Coarse current scale - accuracy	+/- 1% or +/- 1 mA (whichever is greater)	
Programmable current limit range	8 mA	8 A
Programmable current limit accuracy	(0.7) * (current limit)	(1.4) * (current limit)
PTC trip limit at 16 V DCIN	Not applicable	14 A
Fan turn on temperature	1C	40C
Fan turn off temperature	Fan turn on setpoint - 5	
Thermal limit shutdown		50 C

USB Channel

Component	Min	Max
Input voltage range	2.1 V	5.4 V
Continuous current		0.8 A
Integrator cutoff frequency	300 kHz	
Fine current scale - range	50 μ A	40 mA
Fine current scale - resolution	+/- 1% or +/- 50 μ A (whichever is greater)	
Fine current scale - accuracy	30 mA	1 A
Coarse current scale - range	286 μ A	
Coarse current scale - resolution	+/- 1% or +/- 1 mA (whichever is greater)	
Coarse current scale - accuracy	0.52 A	0.85 A
VBUS PTC current hold limit	1.04 A	1.7 A
VBUS PTC current trip limit	22 μ F +/- 20%	

Auxiliary Channel

Component	Min	Max
Input voltage range	0.5 V	5.5 V
Differential input voltage		0.1 V
Integrator cutoff frequency	300 kHz	
Fine current scale - range	0 mA	12 mA
Fine current scale - resolution	2.58 uA	
Fine current scale - accuracy	+/- 1% or +/- 50 uA (whichever is greater)	
Coarse current scale - range	10 mA	500 mA @ $V_{in} = 1V$ 1 A @ $V_{in} = 1.8 V$
Coarse current scale - resolution	100 uA	
Coarse current scale - accuracy	+/- 1% or +/-1mA (whichever is greater)	
Aux + side capacitance	22uF +/- 20%	
Aux + side input current	Not applicable	1% of 0.1 Ω resistor current

Connecting an external supply in series with the Power Monitor(Experimental)

This method is considered experimental, and not recommended for normal use. Users assume all risk of any potential damage to their Power Monitor when used in this configuration.

Some mobile devices, such as 4-cell laptops, require voltage in excess of the Power Monitor's ability to supply. In these circumstances, it is possible to connect an external supply in series with the Power Monitor.

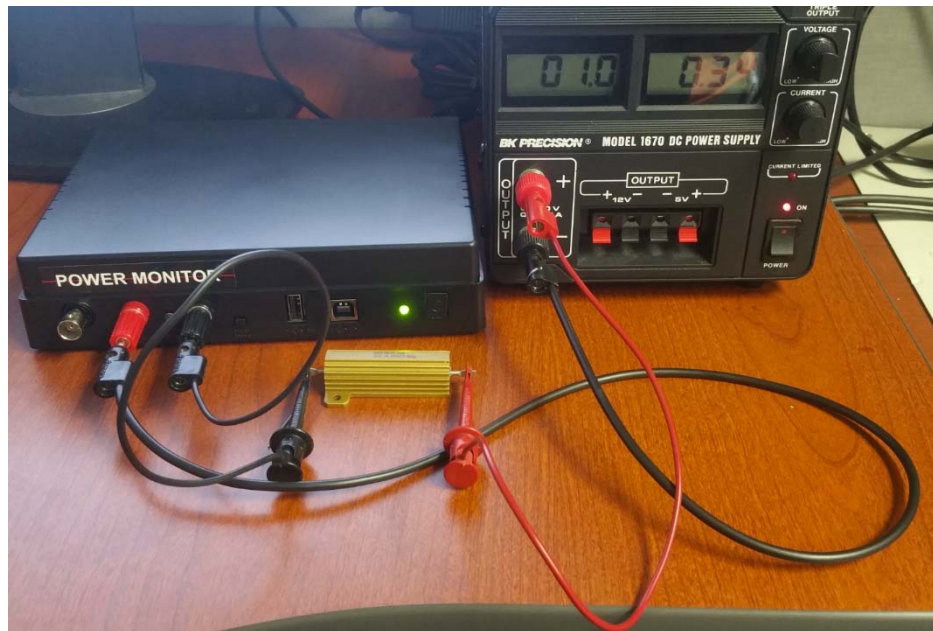

Figure 43 Benchtop Supply in series with the main channel

To connect the Power Monitor in this mode:

1. Connect the Positive terminal of the Power Monitor to the negative terminal of the external supply.
2. Connect the positive terminal of the external supply to the positive terminal of the load
3. Connect the negative terminal of the load to the negative terminal of the Power Monitor
4. Enable the main channel voltage of the Power Monitor.
5. The total voltage on the load will be the sum of the Power Monitor's voltage and the benchtop supply voltage.

While in this configuration, current measurements will tend to be less accurate than when the Power Monitor alone is used, though the degree of inaccuracy has been found to be affected by the quality of the external supply used. This normally takes the form of a constant offset percentage (I.E. If the Power Monitor reports current that is 15% low, all measurements will tend to be 15% below the true value), so it is recommended to take baseline measurements with a known load in order to determine how offset your current measurements will be.

Battery By-pass Modification Instructions

The battery bypass provides a means to isolate the battery power circuit and provide power via a Power Monitor. This ensures that current/power draw measurements are taken from the main power (battery) circuit rather than the charge circuit which would be the case if measurements are taken via the USB port.

In order to modify the battery to properly connect to the Power Monitor please follow these steps.

Note: Wear safety goggles at all times while working with exposed battery terminals and wiring. Removing elements of a battery can be dangerous. Be sure that the area you are working with a battery is protected from fire dangers and do not have flammable items nearby. These modifications are at your own risk and these procedures are not guaranteed to prevent damage or injury.

Note: It's recommended to discharge the battery below 20% before removal to reduce the risk of fire in the event of an accidental puncture of the battery.

Phone disassembly will not be covered here, refer to guides available online (E.g. www.ifixit.com) to find instructions for your device. It will be assumed that the battery is already removed from the device or is ready to be removed.

The battery control board needs to be removed and will act as the intermediary between the device and Power Monitor. The board is typically held within a plastic shroud or rolled into the sleeving at the top or bottom of the battery.

Open the shroud or sleeving until you can see the connection points between the battery itself and the control board. Use a multimeter to probe the points and identify the + and - connections, make note of which connection point on the board is which for reference later. You can now cut the connections, be careful not to short the connections together, and remove the control board.

With the control board removed you can now solder wire (20 gauge recommended) to the + and - connection points of the board, these wires will connect to the Main channel of the Power Monitor. We recommend keeping the connection wires close to the same length as the included grabbers. This length, when combined with the main channel internal sense resistor, mimics the typical resistance of a battery. Refer to page 17 for more details on this.

Re-connect the battery board connector to the phones power input and secure it to the chassis with kapton tape. In order to reassemble the phone you will need to open a hole in the phone body to accommodate the power wires and reassemble the phone. Alternatively simply reattach the screen and any necessary connections and perform testing with the phone partially disassembled. It's recommended that you test the power connections prior to fully reassembling the phone.

Testing the Modifications

Connect the modified phone to the Main channel (Red and Black banana plugs) of the Power Monitor and enable an appropriate voltage (typically 3.7-4.0 volts).

Power Monitor Data and Control Protocol

All control of the Power Monitor happens on the development workstation. The development workstation issues commands and the Power Monitor responds to the commands by completing the operation and sending back a Status packet. The Status packet contains the entire current state of the machine, except when sampling. When sampling, the PowerTool application sends a Start packet to the Power Monitor, and then the Power Monitor sends sample packets continuously back to the PowerTool. When sampling is to be stopped, the PowerTool application sends a Stop packet. The Power Monitor stops sampling and responds with a Status packet. Generally, when the Power Monitor is not sampling, the PowerTool application requests periodic status packets in order to refresh its display.

Command Line Operation of the Power Monitor

Version 4.0.3e or later includes a console application, PowerToolCmd, for execution in batch files/scripts. It connects to your Power Monitor device without opening a GUI and will execute based on your command line settings. The majority of features exposed via the PowerTool API and GUI are available via the command line version. For additional programmatic access, see the PowerTool Automation QuickStart Guide included in the docs directory of the installation which documents our full .Net Interface.

The command line format is:

```
PowerToolCmd [fileName] [switch [switch ...]]
```

where fileName is the optional name of a PT5 file to be loaded into the buffer.

Switches shown in *italics* are required in command line mode.

Switches begin with "-" (hyphen) or "/" (forward slash). The switches are as follows, and are case-insensitive:

Switch	Description
/LOADFILE=file	Same as fileName above
/ISTART	Sampling starts immediately. This has the same effect as setting the trigger start_code to D in command line mode.
<i>/TRIGGER=string</i>	See section on
/TESTMINPOWER=value	Return success if average power (mW) is >= value
/TESTMAXPOWER=value	Return success if average power (mW) is <= value

<code>/SAVEFILE=file</code>	Save capture buffer to this file. The specified filename must include the '.pt5' extension. This also supports absolute file paths using '@"<file path>"' formatting.
<code>/BREAKFILE="path\filename"</code>	Specifies the directory path and filename you want to use in order to break a measurement loop, full path must be surrounded by "".
<code>/CAPTUREDATAMASK=value</code>	See section on capture data mask
<code>/NOHARDWARE</code>	View-only mode; don't connect to a device
<code>/SERIAL=value</code>	Connect to a specific device (Default: first device found)
<code>/KEEPPOWER</code>	Leave Vout enabled on exit
<code>/VOUT=value</code>	Vout voltage value (Default: 3.70V)
<code>/STARTCURRENTLIM=value</code>	Sets the start/ power-up current limit. Default is 0.5A if not set.
<code>/RUNCURRENTLIM=value</code>	Sets the runtime current limit. Default is 4.6A if not set.
<code>/TEMPDIR=path</code>	Override temporary directory (Default: %My Documents%\PowerTool)
<code>/USBPASSTHROUGH=mode</code> <code>/USB=mode</code>	USB passthrough mode: AUTO, ON, or OFF (Default: AUTO)
<code>/NOEXITWAIT</code>	Program exits without waiting for "Press any key..."
<code>/EXITCODES</code>	Lists program exit codes
<code>/?</code> , <code>/H</code> , <code>/HELP</code>	Lists command-line switches

A sample full command line argument would be be:

```
PowerToolCmd.exe /savefile=datafile.pt4 /trigger=DBA300A500TYC20000A500
/vout=3.7 /keeppower /noexitwait
```

See details below to understand what the above trigger specifies.

Trigger codes

The following is the syntax of a trigger code:

```
{A|Bn|Cnt|Dqrn|E}{An|Bn}T[{Yn}]{A|Bn|Cn|Dnt|Eqrn}[An]
```

The capital letters are literals. "n" represents a numeric quantity (in positive decimal or integer values, depending on the code), and "q", "r" and "t" are place-holders for code letters, explained below.

The 'T' is the dividing line in the trigger code between values that are interpreted as start conditions (those before the 'T') and values that are interpreted as stop conditions (those after the 'T').

At the highest level, the string breaks down into:

<start_code><optional_start_qualifier>T<optional_export_flag><stop_code><optional_stop_qualifier>

The following table lists the possible values of **<start_code>**:

Code	Meaning
A	Manual start [Interpreted as Start immediately when running in command line mode]
Bn	Start after "n" markers, where "n" is a positive integer
Cnt	Start after "n" time units of type "t" (see "t" below), where "n" is a positive integer
Dqrn	Start when quantity "q" has relationship "r" with the number "n" (see "q" and "r" below), where "n" is a positive decimal
E	Start immediately

Only one start_code may be specified at a time.

Note: These export codes changed values in 4.0.4.12 to add the support to start based on time. Codes that previously used Cqrn now will use Dqrn. Codes that previously used D, will now use E.

The possible values of **<optional_start_qualifier>** (when present) are:

Code	Meaning
An	Delay capture "n" samples after trigger, where "n" is a positive integer
Bn	Capture "n" samples before trigger, where "n" is a positive integer

Only one optional_start_qualifier may be specified at a time.

If you specify a start_code of A (manual) or E (immediate), a start qualifier of Bn (capture samples before trigger) will be meaningless and will be ignored.

If your start trigger condition is met before the specified number of capture before samples are available, you will have only those measured before your start condition triggers.

The possible values of **<optional_export_flag>** (when present) are:

Code	Meaning
Yn	Auto-export CSV file after stop. "n" is optional. If not specified, or a value of 1 is used, all samples will be exported. If "n" is specified, every "n'th" sample will be written to the CSV file. Allowed values for "n" is 1,10,100,1000, or 10000.

Note: CSV export support were added in version 4.0.4.4. Prior to that version, this feature was not implemented. Granularity of export was added in version 4.0.4.12.

The following table lists the possible values of **<stop_code>**:

Code	Meaning
A	Manual stop [Warning: do NOT use when running in command line mode or you will need to manually kill the process to exit the application.]
Bn	Stop after "n" markers, where "n" is a positive integer
Cn	Stop after "n" samples, where "ne" is a positive integer
Dnt	Stop after "n" time units of type "t" (see "t" below), where "n" is a positive integer
Eqrn	Stop when quantity "q" has relationship "r" with the number "n" (see "q" and "r" below), where "n" is a positive decimal

Only one stop_code may be specified at a time.

The possible values of **<optional_stop_qualifier>** (when present) are:

Code	Meaning
An	Capture "n" samples after trigger, where "n" is a positive integer

The possible values for the quantity code **"q"** are:

Code	Meaning
A	Min power
B	Avg power
C	Max power
D	Min current
E	Avg current
F	Max current
G	Min Vout
H	Avg Vout
I	Max Vout

Power is calculated in mWatts. Current is calculated in mAmps. Voltage is calculated in Volts.

The possible values of relationship code **"r"** are as follows:

Code	Meaning
A	>=

B	<=
C	Rises above
D	Falls below

The possible values of the time-unit code "t" are as follows:

Code	Meaning
A	Seconds (s)
B	Milliseconds (ms)

The shortest time allowed is 1 msec. The longest time allowed to be specified is equivalent to 4 weeks.

For example, a trigger code "DBA300A500TYC20000A500" would be interpreted as follows:

Code	Meaning
DBA300	Start capture after average power falls below 300 mW
A500	Delay capture 500 samples after trigger
T	Fixed delimiter
Y	Auto-export CSV file after stop, with all available samples
C20000	Stop capture after 20000 samples
A500	Capture 500 samples after trigger

If no trigger code is specified at all, a default of 'ATA' will be used, which is how the main GUI PowerTool application starts. This is not desirable for command-line operation, as it causes it to run in manual exit mode and there is no way to issue a signal to exit the application from the executing command line. When running in command line mode, you should be sure to specify a TRIGGER setting with a stop_code of other than A.

The main PowerTool GUI application has the ability to help you formulate trigger codes for use with the command line version of the application. From the PowerTool GUI application, select "Set Capture Triggers", put in your desired settings, and then select "Code". The resulting trigger code will be displayed in a separate window.

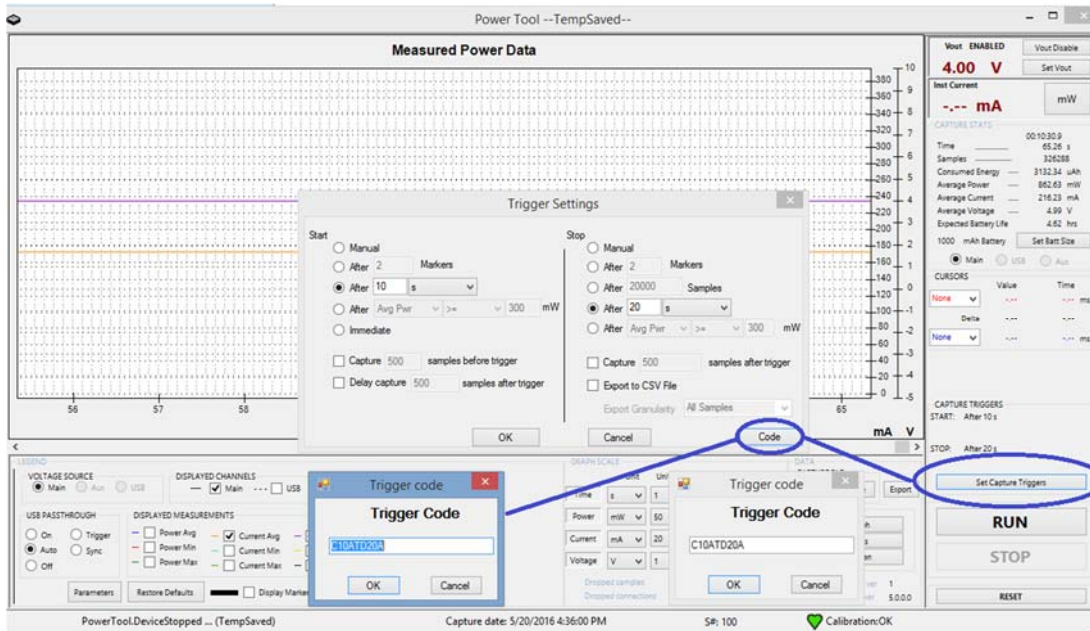

Figure 44 Using the GUI to get a trigger code

Capture Data Mask

The capture data mask is a 16-bit quantity that specifies the data to be captured. It can be expressed either in decimal or hexadecimal (using C-style "0x" notation), but it is most naturally expressed in hex, since it is a combination of discrete bit values. Details on the capture data mask are provided in the [PT5 definition part](#) of this document.

The capture data mask stores the values you have specified in the UI to preserve your preferences in the ini file, and is also how you specify what to export when using command line operation.

Power Monitor Exit Codes

When the PowerTool is closed, it provides an exit code that indicates why the software was closed. The exit codes include but are not limited to:

- Test complete OK
- Unable to find hardware
- Hardware calibration failed
- Disk space check fail
- Capture file write error
- Capture hardware error
- Capture buffer overrun

PT5 file format

A PT5 file consists of three main sections:

- A fixed-length header (212 bytes), at file offset 0
- A variable-length Status packet at file offset 272
- Multiple occurrences of variable-length sample data, starting at file offset 1024. All samples are recorded at a frequency of 5 kHz. Each sample is an n-tuple, the content of which is selectable at run-time.

Header section

The first 212 bytes are the header, as follows:

Name	Description	C# data type	Bytes	File offset
headSize	Header size	int	4	0
Name	"PowerTool"	string	20	4
batterySize	mAh	int	4	24
captureDate	System.DateTime binary	long	8	28
serialNumber	Power Monitor serial number	string	20	36
calibrationStatus	OK (0) or FAILED (1)	CalibrationStatus enum	4	56
voutSetting	Typical (0), Low (1), High (2), or Custom (3)	VoutSetting enum	4	60
voutValue	Main voltage output	float	4	64
hardwareRate	Hz	int	4	68
softwareRate	Hz	float	4	72
powerField	Data selection for Power	SelectField enum	4	76
currentField	Data selection for Current	SelectField enum	4	80
voltageField	Data selection for Voltage	SelectField enum	4	84
captureSetting	Trigger specification	string	30	88
swVersion	PowerTool version	string	10	118
runMode	NoGUI (0) or GUI (1)	RunMode enum	4	128
exitCode	Application exit code	int	4	132
totalCount	Count of data samples	long	8	136
statusOffset	File offset of Status Packet	ushort	2	144
statusSize	Size (bytes) of Status Packet	ushort	2	146
sampleOffset	File offset of Sample data	ushort	2	148
sampleSize	Size (bytes) of each individual sample	ushort	2	150
initialMainVoltage	See Table 6	ushort	2	152
initialUsbVoltage	See Table 6	ushort	2	154

Name	Description	C# data type	Bytes	File offset
initialAuxVoltage	See Table 6	ushort	2	156
captureDataMask	Mask indicating which data is being captured (see capturedatamask)	ushort	2	158
sampleCount	Sample count	ulong	8	160
missingCount	Count of missing samples	ulong	8	168
sumMainVoltage	Sum of main output voltage (V). Divide by (sampleCount - missingCount) for Average.	float	4	176
sumMainCurrent	Sum of main current (mA)	float	4	180
sumMainPower	Sum of main power (mW)	float	4	184
sumUsbVoltage	Sum of USB voltage (V)	float	4	188
sumUsbCurrent	Sum of USB current (mA)	float	4	192
sumUsbPower	Sum of USB power (mW)	float	4	196
sumAuxVoltage	Sum of Aux voltage (V)	float	4	200
sumAuxCurrent	Sum of Aux current (mA)	float	4	204
sumAuxPower	Sum of Aux power (mW)	float	4	208
Total length:				212

Table 2 Header layout

All strings are length-prefixed (one-byte), and are blank-padded to their fixed length, suitable for reading with `BinaryReader.ReadString()`. The lengths listed include the length byte.

The enumerations are as follows:

Enumeration	Definition	Description
CalibrationStatus	OK=0 Failed=1	Status of calibration
VoutSetting	Typical=0 (3.7 V) Low=1 (3.35 V) High=2 (4.2 V) Custom=3	Type out Vout setting
SelectField	None=0x00 Avg=0x01 Min=0x02 Max=0x04 Main=0x08 Usb=0x10	Masks describing which channel (Main,Aux1,Aux2,Marker) and statistic (Avg,Min,Max) are being recorded

	Aux=0x20 Marker=0x40	
RunMode	NoGUI=0 GUI=1	Whether or not PowerTool was running in GUI mode

Table 3 Header enumerations

The **captureDataMask** indicates which of the three data channels are captured: Main, USB, or AUX and which aspects of Voltage, Current, and Power fields are captured. Each channel and field is represented by one bit in the mask. The mask is thus the bitwise-OR of the channel(s) and field(s) to be captured.

The bit values for the channels are as follows:

Mask	Channel
0x1000	Main
0x2000	USB
0x4000	Aux

The bit values for the fields are as follows:

Mask	Field	Mask	Field	Mask	Field
0x0100	Min Voltage	0x0010	Min Current	0x0001	Min Power
0x0200	Avg Voltage	0x0020	Avg Current	0x0002	Avg Power
0x0400	Max Voltage	0x0040	Max Current	0x0004	Max Power

The data is bitwise-OR'd together to specify what should be captured.

For example:

0x1777 (default)	Main channel, all data for all fields
0x1020	Main Channel, Average current only
0x1222	Main Channel, Average data for all fields
0x2002	USB Channel, Average power only
0x1637	Main Channel, Avg and Max Voltage, Min and Avg Current, all Power data
0x2777	Main and USB channel, all data for all fields

The file is padded with zeros until offset 272 (144+128), where a Status packet from the Power Monitor hardware is recorded. Several fields have been maintained for legacy support of the pt4 standard, but their use by the Power Monitor software is now deprecated. These are marked with the DEPRICATED description.

Name	Description	C# data type	Bytes	File offset	Packet offset
------	-------------	--------------	-------	-------------	---------------

packetLength	Length-1 of packet This is variable. All implementations should use the packetLength to determine where to pull the checksum.	byte	1	272	0
packetType	0x10 for Status packet	byte	1	273	1
firmwareVersion	Firmware version	byte	1	274	2
protocolVersion	Protocol version	byte	1	275	3
mainFineCurrent	DEPRICATED	short (signed)	2	276	4
usbFineCurrent	DEPRICATED	short (signed)	2	278	6
auxFineCurrent	DEPRICATED	short (signed)	2	280	8
voltage1	DEPRICATED	ushort	2	282	10
mainCoarseCurrent	DEPRICATED	short (signed)	2	284	12
usbCoarseCurrent	DEPRICATED	short (signed)	2	286	14
auxCoarseCurrent	DEPRICATED	short (signed)	2	288	16
voltage2	DEPRICATED	ushort	2	290	18
outputVoltageSetting	DEPRICATED	byte	1	292	20
temperature	Degrees Celsius	byte	1	293	21
status	DEPRICATED	byte	1	294	22

reserved	Unused	byte	1	295	23
leds	DEPRICATED	byte	1	296	24
mainFineResistor	DEPRICATED	sbyte (signed)	1	297	25
serialNumber	Serial number	ushort	2	298	26
sampleRate	kHz	byte	1	300	28
dacCalLow	DAC input for 2.5 V output	ushort	2	301	29
dacCalHigh	DAC input for 4.096 V output	ushort	2	303	31
powerUpCurrentLimit	Max current during power-up (amps = $8 * ((1 - \text{limit}) / 1023)$)	ushort	2	305	33
runTimeCurrentLimit	Max current during sample run (amps = $8 * ((1 - \text{limit}) / 1023)$)	ushort	2	307	35
powerUpTime	ms	byte	1	309	37
usbFineResistor	DEPRICATED	sybte (signed)	1	310	38
auxFineResistor	DEPRICATED	sbyte (signed)	1	311	39
initialUsbVoltage	See Table 6	ushort	2	312	40
initialAuxVoltage	See Table 6	ushort	2	314	42
hardwareRevision	Hardware revision level	byte	1	312	44

	(1=A, 2=B, 3=C, etc.)				
temperatureLimit	Degrees Celsius	byte	1	313	45
usbPassthroughMode	0=off, 1=on, 2=auto	byte	1	314	46
mainCoarseResistor	DEPRICATED	sbyte (signed)	1	315	47
usbCoarseResistor	DEPRICATED	sbyte (signed)	1	316	48
auxCoarseResistor	DEPRICATED	sbyte (signed)	1	317	49
defMainFineResistor	DEPRICATED	sbyte (signed)	1	318	50
defUsbFineResistor	DEPRICATED	sbyte (signed)	1	319	51
defAuxFineResistor	DEPRICATED	sbyte (signed)	1	320	52
defMainCoarseResistor	DEPRICATED	sbyte (signed)	1	321	53
defUsbCoarseResistor	DEPRICATED	sbyte (signed)	1	322	54
defAuxCoarseResistor	DEPRICATED	sbyte (signed)	1	323	55
eventCode	DEPRICATED	byte	1	324	56

eventData	Supplementary event data (interpretation depends on eventCode)	ushort	2	325	57
Measurement Dataset	0 = Main + Aux Voltages. 1 = USB + Aux Voltages	Byte	1	327	59
Main Voltage Setting	Main Output voltage	Int	4	328	60
Main Fine Scale	Current scaling by channel	UInt32	4	332	64
Main Coarse Scale	Current scaling by channel	UInt32	4	336	68
USB Fine Scale	Current scaling by channel	UInt32	4	340	72
USB Coarse scale	Current scaling by channel	UInt32	4	344	76
Aux Fine Scale	Current scaling by channel	UInt32	4	348	80
Aux Coarse Scale	Current scaling by channel	UInt32	4	352	84
Main Fine Zero Offset	Zero-level offset by channel	short (signed)	2	356	88
Main Coarse Zero Offset	Zero-level offset by channel	short (signed)	2	358	90
USB Fine Zero Offset	Zero-level offset by channel	short (signed)	2	360	92
USB Coarse Zero Offset	Zero-level offset by channel	short (signed)	2	362	94
hardwareModel	0 = Unknown, 1 = LVPM, 2 = HVPM.	byte	1	364	96
reserved	Reserved for future use	varied	varied	365	97
checksum	Checksum byte	byte	1	varied	varied

Total length					varied
---------------------	--	--	--	--	---------------

Table 4 Status packet layout

The file is then padded with zeros up until file offset 1024, where the sample data begins.

Interpreting the Sample Data

Beginning at offset 1024, sample data is recorded at a rate indicated in the Status Packet. Each sample consists of up to four two-byte quantities, three of which are optional, depending on the **captureDataMask** field at offset 158.

The total count of samples is given by the **totalCount** field of the header.

The four quantities are the current measurements for the Main, Usb, and/or Aux channels, and a voltage for the channel indicated by the **voltageIsAux** bit of the **leds** field of the **Status** packet (file offset 296). If the bit is set, the voltage is the Aux channel voltage, otherwise it is the Main channel voltage.

Current measurements were updated in the pt5 format. They are no longer separated into course and fine measurements.

The layout of each sample is as follows:

Field	C# Data Type	Bytes	Tick value	Present if:
Main Current	short (signed)	4	1 uA	(captureDataMask & 0x1000) != 0
USB Current	short (signed)	4	1 uA	(captureDataMask & 0x2000) != 0
Aux Current	short (signed)	4	1 uA	(captureDataMask & 0x4000) != 0
Main or Aux Voltage, and Markers	ushort (unsigned)	2	See Table 6.	Always

Table 5 Sample layout

The following table lists the value of each voltage tick in microvolts (uV), depending on the hardware revision level and the channel:

Hardware Revision	Main	USB	Aux
--------------------------	-------------	------------	------------

A	62.5 uV / tick	62.5 uV / tick	62.5 uV / tick
B	125 uV / tick	125 uV / tick	62.5 uV / tick
C	125 uV / tick	125 uV / tick	125 uV / tick
High-Voltage	500 uV/ tick	125 uV / tick	500 uV/ tick

Table 6 Voltage units

Missing data values

In order to account for the time gaps caused by calibration cycles, delays in communication between the power monitor and the PC host, or other causes, the PowerTool software inserts missing data indicators. For current measurements, missing data is recorded as 0x8001, while for voltage the missing value is 0xFFFF.

Should a missing value be encountered within a given sample, the entire sample should be treated as missing, but the 200 uSec of time for the sample should be accounted for.

Example C# program to process a PT5 file

Pt5Reader, a sample C# console application is included with the installation. Look in the 'DeveloperExamples' directory where you installed the Power Monitor application. The DeveloperTools solution will load the Pt5Reader project. Alternatively, the 'src/Pt5Reader' subdirectory contains the project file. Pt5Reader takes a pt5 filename as an input argument and outputs the file's contents to the console.

Equipment Maintenance and Service

Inspection of the Power monitor for safety

1. Visually inspect the outer casing, ensure the air vents are not clogged or obstructed.
2. Inspect the Power Supply and cords, ensure the cords are not frayed or damaged in any way. Exposed wiring may present a fire hazard. If the Power Supply is damaged or defective, contact Monsoon Solutions for a replacement. Do not use a third-party power supply, which may have an inaccurate pinout, and may be inadequately rated to supply the 16V, 7.5A requirements of the Power Monitor.
3. Visually inspect all ports for signs of damage. Especially banana jacks, as damage to the plastic covers may create a hazardous condition.
4. Do not open the case. If internal components need maintenance or repair, contact info@msoon.com for instructions on shipping the unit in for repair.
5. When powering on the unit, an amber light indicates a fault condition, while green light indicates the unit is functioning normally.

How to Clean the Power Monitor

Ensure the power switch is off and all connections are unplugged before cleaning. Use plastic-safe isopropyl alcohol wipes to clean the outside case of the Power Monitor.

Monsoon Solutions does not recommend opening the case, as this could result in damage to the device.

Other than isopropyl alcohol for cleaning, the Power Monitor should not be exposed to any liquids.

This page purposely left blank.